

**Report By:**

National TAB  
105 Stone Village Drive  
Fort Mill, SC 29708



**Report: Wingstop (Salinas, CA) TAB Report**

**Function: Test, Adjust, & Balance**

**Date: 12/18/2025**

**Completed By: National TAB**

# **PROJECT**

## **Wingstop (Salinas, CA)**

1598 N Sanborn Road

Salinas, CA 93905

### **Client**

KMS Resource Group Inc.

8502 E CHAPMAN AVE

SUITE 274

ORANGE, CA 92869

# National TAB

Project: Wingstop (Salinas, CA)

## Table Of Contents

<b>Section</b>	<b>Page #</b>
Certification	3
Equipment Calibration	4
Abbreviations	5
GRD LAYOUT	6
AHU/RTU	8
FAN - Supply	14
FAN - Exhaust	16
Kitchen Hood Type I	20



# CERTIFICATION

**PROJECT:** Wingstop (Salinas, CA)

The data presented in this report is a record of system measurements and final adjustments that have been obtained in accordance with the current edition of the NEBB *Procedural Standards for Testing, Adjusting, and Balancing of Environmental Systems*. Any variances from design quantities, which exceed NEBB tolerances, are noted in the Test-Adjust-Balance Report Project Summary.

The air distribution system has been tested and balanced and final adjustments have been made in accordance with NEBB standards and the project specifications.

**NEBB TAB FIRM:** National TAB-Southeast

**REGISTRATION NO:** 3755

**CERTIFIED BY:** J. Scott Springer 23312

**DATE:** 12/18/2025

The hydronic distribution system has been tested and balanced and final adjustments have been made in accordance with NEBB standards and the project specifications.

**NEBB TAB FIRM:** National TAB-Southeast

**REGISTRATION NO:** 3755

**CERTIFIED BY:** J. Scott Springer 23312

**DATE:** \_\_\_\_\_

## Submitted and Certified by:

**NEBB TAB FIRM:** National TAB-Southeast

**TAB PROFESSIONAL:** J. Scott Springer

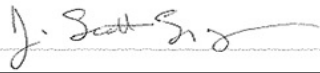
**SIGNATURE:** 

**REGISTRATION NO:** 3755 (NTAB) / 23312

**CERTIFICATION EXP:** 12/31/2025





# National TAB



## Testing, Adjusting, and Balancing Equipment

Function		Range	Minimum Accuracy	Instrument Information	Calibration Date	Date Due
AIR	AIR PRESSURE	0 in wg to 10 in wg	2% +/- 0.001 in wg	Shortridge ADM-860C S/N M19547	9/30/2025	9/30/2026
	AIR VELOCITY INSTRUMENT	50 fpm to 3900 fpm	+/- 5 % +/- 7 fpm	Shortridge ADM-860C S/N M19547	9/30/2025	9/30/2026
	DIRECT HOOD READING	100 cfm to 2000 cfm	+/- 3 % +/- 7 cfm	Evergreen Telemetry Capture Hood	8/12/2025	8/12/2026
TEMPERATURE	AIR METER	-20 F to 240 F	+/- .5 % 2 F	Cooper ATKINS - SRH77A S/N 041018026	9/30/2025	9/30/2026
	AIR PROBE	-20 F to 240 F	+/- .5 % 2 F	Cooper ATKINS - 4011 S/N 33-20	9/30/2025	9/30/2026
	IMMERSION METER	-20 F to 240 F	+/- .5 % 2 F	Cooper ATKINS - SRH77A S/N 041018026	9/30/2025	9/30/2026
	IMMERSION PROBE	-20 F to 240 F	+/- .5 % 2 F	Cooper ATKINS - 4011 S/N 33-20	9/30/2025	9/30/2026
	CONTACT METER	-20 F to 240 F	+/- .5 % 2 F	Cooper ATKINS - SRH77A S/N 041018026	9/30/2025	9/30/2026
	CONTACT PROBE	-20 F to 240 F	+/- .5 % 2 F	Cooper ATKINS - 4011 S/N 33-20	9/30/2025	9/30/2026
HUMIDITY	HUMIDITY PROBE	10 % RH to 90 % RH	3% of reading	Cooper ATKINS - SRH77A S/N 041018026	9/30/2025	9/30/2026
ELECTRICAL	VOLTAGE MEASUREMENT	0 VAC to 600 VAC	2 % reading +/- 5 digits	Dwyer CM-1 - S/N 190800099	9/30/2025	9/30/2026
	AMPERAGE MEASUREMENT	0 Amperers to 100 Amperes	2 % reading +/- 5 digits	Dwyer CM-1 - S/N 190800099	9/30/2025	9/30/2026
ROTATION	ROTATION MEASUREMENT	60 rpm to 5000 rpm	2 % reading 2 rpm	Dwyer TAC-L - S/N S1100123	9/30/2025	9/30/2026
HYDRONIC	PRESSURE MEASUREMENT	-30 in Hg to 200 psi	±2% of reading +/- 1 psi	Shortridge HDM 250 - S/N W25059	6/18/2025	6/18/2026
	DIFFERENTIAL PRESSURE MEASUREMENT	0 psi - 80 psi	±2% of reading +/- 1 psi	Shortridge HDM 250 - S/N W25059	6/18/2025	6/18/2026
DALT	DUCT LEAKAGE	-10" - +10" wc	±1% of reading +/- .0004" wc	Kanomax DALT 6900 S/N: 080439	3/7/2025	3/7/2026

## Abbreviation List

A = Area (ft <sup>2</sup> )	S.F. = Service Factor
AHU = Air Handling Unit	SF = Supply Fan
A <sub>k</sub> = Effective Area	SP = Static Pressure
BHP = Brake Horsepower (IP) HP	SR = Supply Register
Btu = British Thermal Unit	T = Temperature
Btu/h = Btuh = BTUH = BTU/Hour	T <sub>ma</sub> = Mixed Air Temperature
CL = Center Distance (used in belt formula)	T <sub>oa</sub> = Outside Air Temperature
CD = Ceiling Diffuser	T <sub>ra</sub> = Return Air Temperature
CF = Correction Factor	H = Head (in wc, ft wc, psi)
CFM = Volumetric Flow: Cubic Feet Per Minute	h = Enthalpy
CO <sub>2</sub> = Carbon Dioxide	HP = Horsepower
CO = Carbon Monoxide	hr = Hour
C <sub>v</sub> = Flow Constant	K <sub>v</sub> = Flow constant (SI)
d = Diameter (in.) IP	kW = Kilowatt = 1000 Watts
Δ = Difference or Change (Final - Initial)	LAT = Leaving Air Temperature
DB = Dry Bulb	lb = Pounds
EA = Exhaust Air	LWT = Leaving Water Temperature
EAT = Entering Air Temperature	ma = Mixed Air
EF = Exhaust Fan	MIN = Minimum
Eff = Efficiency	MAX = Maximum
EG = Exhaust Grille	N/A = Not Applicable
ESP = External Static Pressure	NA = No Access
EWT = Entering Water Temperature	NL = Not Listed
°F = Degrees Fahrenheit, °F	NPSHA = Net Positive Suction Head Available
FPB = Fan Powered Box	NS = Not Specified
FLA = Full Load Amps	OA = Outside Air
fpm = Feet per Minute (fpm)	OAT = Outside Air Temperature
ft = Foot	PD = Sheave Pitch Diameter
gal = Gallons	P.D. = Pressure Drop
GPM = Gallons Per Minute (GPM)	PF = Power Factor
h = Enthalpy (BTU/lb dry air)	SG = Supply Grille
P = Pressure	SR = Supply Register
ppm = parts per million	TP = Total Pressure
psi = Pounds Per Square Inch	T <sub>ra</sub> = Return Air Temperature
psid = PSI Differential	TS = Tip Speed (fpm) IP, (m/s) SI
r = Radius (in)	TSP = Total Static Pressure
% <sub>ra</sub> = % of Return Air	V = Velocity
RA = Return Air	VAV = Variable Air Volume
RAT = Return Air Temperature	VD = Volume Damper
RF = Return Fan	VFD = Variable Frequency Drive
RG = Return Grille	W = Watt
RH = Relative Humidity	WB = Wet Bulb
RPM = Revolutions Per Minute	wg = wc = water gauge = water column
RTU = Roof Top Unit	WHP = Water Horsepower (IP)
SA = Supply Air	ω = Humidity Ratio

**NOTE: EXHAUST OUTLETS SERVING GREASE DUCT SYSTEMS:**

**ROOF OUTLETS SHALL MEET THE FOLLOWING REQUIREMENTS:**

1. SHALL BE MINIMUM 24 INCHES ABOVE THE ROOF SURFACE WITH AIRFLOW DIRECTED UPWARDS.
3. SHALL BE MINIMUM 10 FEET FROM AIR INTAKE OPENING INCLUDING A/C UNITS, AIR INTAKE OPENINGS, WINDOWS, ETC.
3. SHALL BE MINIMUM 10 FEET ABOVE ADJOINING GRADE.
4. SHALL BE MINIMUM 10 FEET AWAY FROM PARTS OF THE SAME BUILDING INCLUDING PARAPETS, EQUIPMENT SCREENS, ROOF PUP OUT, ETC. AND ADJACENT/ ADJOINING BUILDINGS.

NOTE: UP BLAST GREASE EXHAUST FANS SHALL HAVE A HINGED BASE FOR CLEANING AT ROOF LEVEL.

NOTE: A 10' MINIMUM CLEARANCE IS REQUIRED FROM ALL PLUMBING AND EXHAUST VENTS TO AIR INTAKE VENTS.

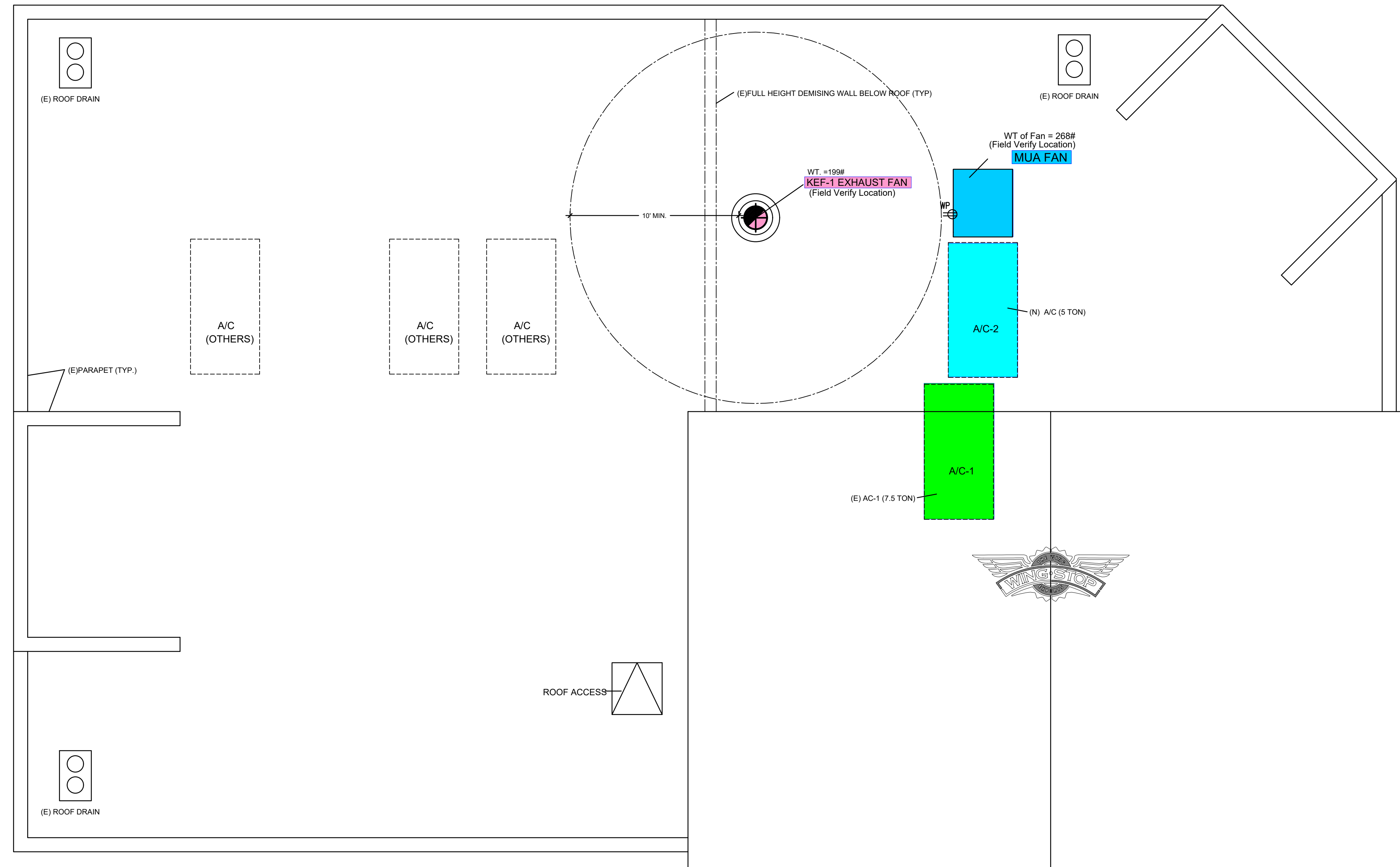

NOTE: A 10' MINIMUM CLEARANCE IS REQUIRED FROM ALL PLUMBING AND EXHAUST VENTS TO AIR INTAKE VENTS.

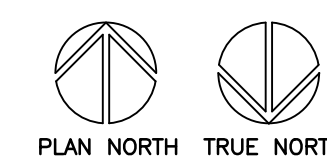

**ROOF EQUIPMENT PLAN**

SCALE: 1/4" = 1'-0"

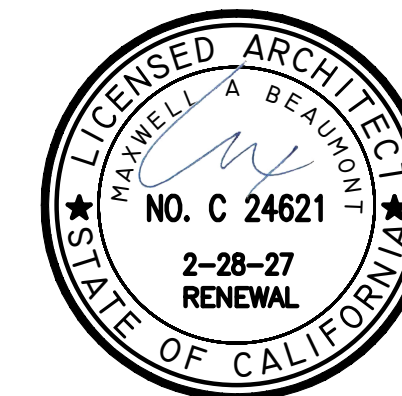

REV. DATE	NO.
06-06-2025	1

ARCHITECT:  
BEAUMONT & ASSOCIATES  
MAXWELL A. BEAUMONT, ARCHITECT  
EMERYVILLE, CALIFORNIA  
DESIGN@ACUTE-CONSULTING.COM

Acute Consulting, Inc.  
29 ORINDA WAY, #1267  
ORINDA, CA 94563  
925-818-4132

WING STOP RESTAURANT  
BORONDA PLAZA  
1588 N. SANBORN ROAD, SUITE C  
SALINAS, CA 93905  
STORE GL#10105



DWG DATE:  
03/10/25  
DRAWN BY:  
EAL

EQUIPMENT  
ROOF PLAN  
**M.I.**

**2022 CAL GREEN REQUIREMENTS:**  
**5.410.4 TESTING AND ADJUSTING.** New buildings less than 10,000 square feet. Testing and adjusting of systems shall be required for new buildings less than 10,000 square feet or new systems to serve an addition or alteration subject to Section 303.1.

**5.410.4.2 (Reserved)**

**Note:** For energy-related systems under the scope (Section 100) of the California Energy Code, including heating, ventilation, air conditioning (HVAC) systems and controls, indoor lighting system and controls, as well as water heating systems and controls, refer to California Energy Code Section 120.8 for commissioning requirements and Sections 120.5, 120.6, 130.4, and 140.9(b)(3) for additional testing requirements of specific systems.

**5.410.4.2 Systems.** Develop a written plan of procedures for testing and adjusting systems. Systems to be included for testing and adjusting shall include at a minimum, as applicable to the project:

1. Renewable energy systems.
2. Landscape irrigation systems.
3. Water reuse systems.

**5.410.4.3 Procedures.** Perform testing and adjusting procedures in accordance with manufacturer's specifications and applicable standards on each system.

**5.410.4.3.1 HVAC balancing.** In addition to testing and adjusting, before a new space-conditioning system serving a building or space is operated for normal use, the system shall be balanced in accordance with the procedures defined by the Testing Adjusting and Balancing Bureau National Standards, the National Environmental Balancing Bureau Procedural Standards, Associated Air Balance Council National Standards or as approved by the enforcing agency.

**SECTION 5.504 POLLUTANT CONTROL**

**5.504.1 TEMPORARY VENTILATION.** The permanent HVAC system shall only be used during construction if necessary to condition the building or areas of addition or alteration within the required temperature range for material and equipment installation. If the HVAC system is used during construction, use return air filters with a Minimum Efficiency Reporting Value (MERV) of 8, based on ASHRAE 52.2-1999, or an average efficiency of 30% based on ASHRAE 52.1-1992. Replace all filters immediately prior to occupancy, or, if the building is occupied during alteration, at the conclusion of construction.

**5.504.3 Covering of duct openings and protection of mechanical equipment during construction.** At the time of rough installation and during storage on the construction site until final startup of the heating, cooling and ventilation equipment, all duct and other related air distribution component openings shall be covered with tape, plastic, sheetmetal or other methods acceptable to the enforcing agency to reduce the amount of dust, water and debris which may enter the system.

**5.504.5.3 Filters.** In mechanically ventilated buildings, provide regularly occupied areas of the building with air filtration media for outside and return air that provides at least a Minimum Efficiency Reporting Value (MERV) of 13. MERV 13 filters shall be installed prior to occupancy, and recommendations for maintenance with filters of the same value shall be included in the operation and maintenance manual.

**Exceptions:** Existing mechanical equipment.

**5.504.5.3.1 Labeling.** Installed filters shall be clearly labeled by the manufacturer indicating the MERV rating.

**5.506.1 OUTSIDE AIR DELIVERY.** For mechanically or naturally ventilated spaces in buildings, meet the minimum requirements of Section 120.1 (Requirements For Ventilation) of the California Energy Code, or the applicable local code, whichever is more stringent, and Division 1, Chapter 4 of CCR, Title 8.

**5.508.1 Ozone depletion and greenhouse gas reductions.** Installations of HVAC, refrigeration and fire suppression equipment shall comply with Sections 5.508.1.1 and 5.508.1.2.

**5.508.1.1 Chlorofluorocarbons (CFCs).** Install HVAC, refrigeration and fire suppression equipment that do not contain CFCs.

**5.508.1.2 Halons.** Install HVAC, refrigeration and fire suppression equipment that do not contain Halons.

**702.1 INSTALLER TRAINING.** HVAC system installers shall be trained and certified in the proper installation of HVAC systems including ducts and equipment by a nationally or regionally recognized training or certification program. Uncertified persons may perform HVAC installations when under the direct supervision and responsibility of a person trained and certified to install HVAC systems or contractor licensed to install HVAC systems. Examples of acceptable HVAC training and certification programs include but are not limited to the following:

1. State certified apprenticeship programs.
2. Public utility training programs.
3. Training programs sponsored by trade, labor or statewide energy consulting or verification organizations.
4. Programs sponsored by manufacturing organizations.
5. Other programs acceptable to the enforcing agency.

**702.2 SPECIAL INSPECTION [HCD].** When required by the enforcing agency, the owner or the responsible entity acting as the owner's agent shall employ one or more special inspectors to provide inspection or other duties necessary to substantiate compliance with this code. Special inspectors shall demonstrate competence to the satisfaction of the enforcing agency for the particular type of inspection or task to be performed. In addition to other certifications or qualifications acceptable to the enforcing agency, the following certifications or education may be considered by the enforcing agency when evaluating the qualifications of a special inspector:

1. Certification by a national or regional green building program or standard publisher.
2. Certification by a statewide energy consulting or verification organization, such as HERS raters, building performance contractors, and home energy auditors.
3. Successful completion of a third party apprentice training program in the appropriate trade.
4. Other programs acceptable to the enforcing agency.

**Notes:**

1. Special inspectors shall be independent entities with no financial interest in the materials or the project they are inspecting for compliance with this code.
2. HERS raters are special inspectors certified by the California Energy Commission (CEC) to rate homes in California according to the Home Energy Rating System (HERS).

**[BSC-CG]** When required by the enforcing agency, the owner or the responsible entity acting as the owner's agent shall employ one or more special inspectors to provide inspection or other duties necessary to substantiate compliance with this code. Special inspectors shall demonstrate competence to the satisfaction of the enforcing agency for the particular type of inspection or task to be performed. In addition, the special inspector shall have a certification from a recognized state, national or international association, as determined by the local agency. The area of certification shall be closely related to the primary job function, as determined by the local agency.

**Note:** Special inspectors shall be independent entities with no financial interest in the materials or the project they are inspecting for compliance with this code.

**703 VERIFICATIONS**

**703.1 DOCUMENTATION.** Documentation used to show compliance with this code shall include but is not limited to, construction documents, plans, specifications, builder or installer certification, inspection reports, or other methods acceptable to the enforcing agency which demonstrate substantial conformance. When specific documentation or special inspection is necessary to verify compliance, that method of compliance will be specified in the appropriate section or identified applicable checklist.

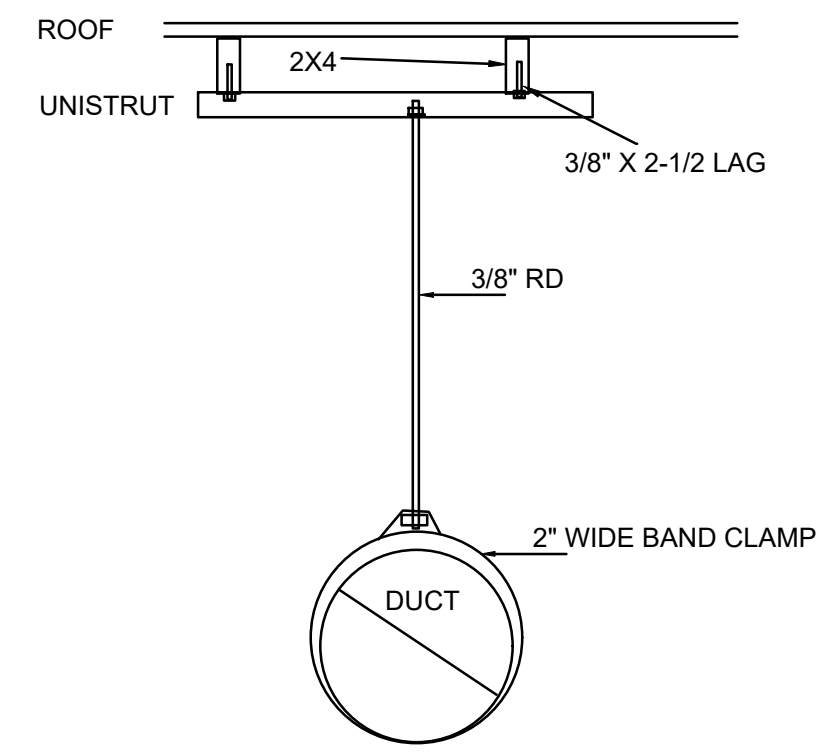

**DUCT SUPPORT DETAIL**  
NTS

SYMBOL LEGEND			
MK. SYMBOL	SPECIFICATIONS	MOUNTING HT.	NOTES
EF	EXHAUST FAN: BROAN #HD80 80CFM SUPPLIER: MELETO ELECTRICAL SUPPLY	MOUNT TO SCHEDULED GYP CEILING	STANDARD WHITE COVER
	LAY-IN HVAC 2X2 SUPPLY REGISTER PROVIDED BY HVAC CONTRACTOR	MOUNT TO SCHEDULED ACOUSTICAL CEILING	SUPPLY REGISTERS AND EXPOSED DUCT TO BE PAINTED P6
N/A	LAY-IN HVAC 2X2 PERFORATED SUPPLY REGISTER PROVIDED BY HVAC CONTRACTOR	MOUNT TO SCHEDULED ACOUSTICAL CEILING LOCATED NEAR HOOD ONLY	SUPPLY REGISTERS AND EXPOSED DUCT TO BE PAINTED P6
N/A	HVAC SUPPLY REGISTER AT ROUND DUCT	MOUNT TO SCHEDULED DUCT AT A MINIMUM OF 8'-0" A.F.F., DUCT SUPPORTS SHALL BE STANDARD HVAC STYLE 2" WIDTH	SUPPLY REGISTERS AND EXPOSED DUCT TO BE PAINTED P6
	MUA PERFORATED SUPPLY PLENUM (AT HOOD)		
	AC PERFORATED SUPPLY PLENUM (AT HOOD)		
	2X4 RETURN REGISTER		
		SMOKE DETECTOR IN SUPPLY LINE IN AC-1 (MUST BE IN COMPLIANCE WITH CFC 907.3.1)	

**HVAC SCHEDULE**

(E)AC-1	<b>7.5 TON HVAC RTU</b> ELECTRICAL - 208 V/3 Ph/60 Hz, 8.7 KW HEATING - 200,000 BTU SUPPLY AIR - 2650 CFM
(N)AC-2	<b>5 TON HVAC RTU</b> ELECTRICAL - 208 V/3 Ph/60 Hz, 8.7 KW HEATING - 200,000 BTU SUPPLY AIR - 2000 CFM

AIR BALANCE SCHEDULE:						
UNIT MARK	HVAC AIR	HVAC OUTSIDE AIR	MAKE-UP AIR	EXHAUST AIR	RETURN AIR	NOTES
AC-1	2650 CFM	500	-	-	-	EXISTING
AC-2	2000 CFM	300 CFM	-	-	-	
MUA	-	-	1998 CFM	-	-	
KEF-1	-	-	-	2475 CFM	-	
EF-1	-	-	-	80 CFM	-	
BLDG. TOTAL	4650 CFM	800 CFM	1998 CFM	2555 CFM	2443 CFM	NET 0 CFM
			MAKE UP:			
			A/C UNITS OUTSIDE AIR INTAKE			+800
			FAN MAKE UP:			+1998
						2798 CFM
			EXHAUST:			
			HOOD EXHAUST			-2475
			GENERAL EXHAUST			-80
						2555 CFM
			BALANCE RESULTS:			
			MAKE-UP			+2555
			EXHAUST			-2555
						0 CFM

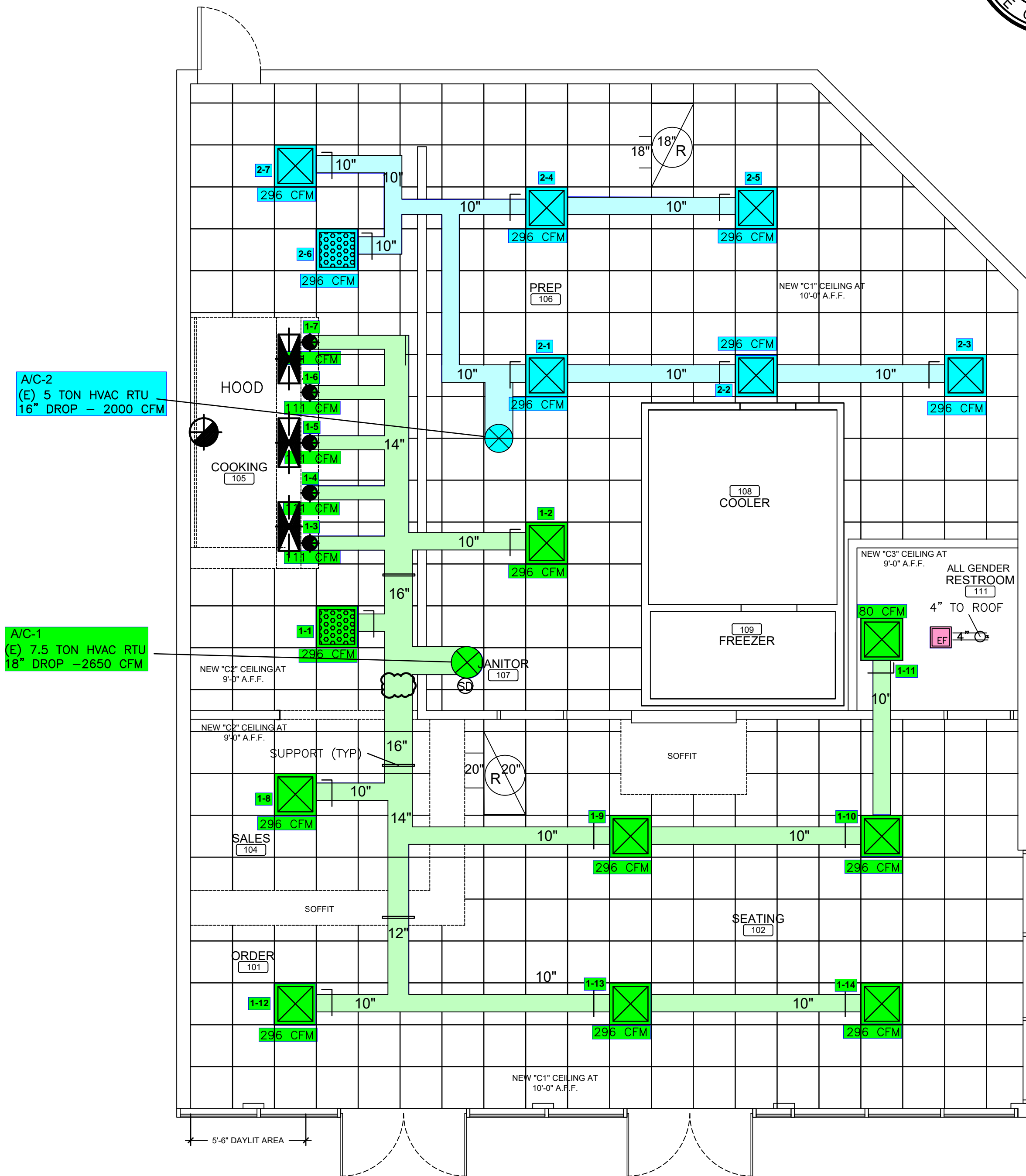

**HVAC PLAN**  
SCALE: 1/4" = 1'-0"

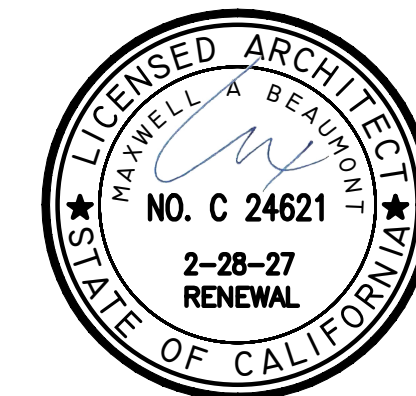

REV. DATE	NO.
06-06-2025	I

ARCHITECT:  
BEAUMONT & ASSOCIATES  
MAXWELL A. BEAUMONT, ARCHITECT  
EMERYVILLE, CALIFORNIA  
DESIGN@ACUTE-CONSULTING.COM

Acute Consulting, Inc.  
29 ORINDA WAY, #1267  
ORINDA, CA 94563  
925-818-4132

WING STOP RESTAURANT  
BORONDA PLAZA  
1598 N. SANBORN ROAD, SUITE C  
SALINAS, CA 93305  
STORE GL#FA1103



DWG DATE:  
03/10/25

DRAWN BY:  
EAL

HVAC  
FLOOR PLAN

M.2

# National TAB

Project: Wingstop (Salinas, CA)

System/Unit: AHU/RTU



Asset: (E) A/C-1

AREA:

Unit Data	
	Actual
MFG	CARRIER
Serial Num	4424P65779
Model Num	50FCQM08A5A5A0A
Configuration	RTU
Num OA Filters 1	1
OA Filter Size 1	35X20
Num PreFilter 1	4
PreFilter Size 1	20X20X2

Test Data		
	Design	Actual
SF CFM	3098	3175
SF RPM	-	1251
RA CFM	2598	2672
OA CFM	500	503
RL Voltage	208	207/207/207
RL Amperage	6.4	2.03/2.01/2.03
OA Damper Position	-	19%

Motor Data	
	Actual
Phase	3
Rated Voltage	208
Rated Amperage	6.4
Service Factor	1.0

Performance Data		
	Design	Actual
MA Plenum SP	-	-0.37"
Fan Suction SP	-	-0.69"
Fan Discharge SP	-	0.45"
Total ESP	-	0.82"
Fan Total SP	-	1.14"

Completed By: Zack Eismin on 12/11/2025

## Unit Data - PHOTO LOG



12/11/2025

# National TAB

Project:Wingstop (Salinas, CA)

## AHU/RTU



### Diffuser Supply (GRD)

#### (E) A/C-1/

Asset							
Asset Name	Location	Type	Size	DESIGN CFM	CFM(1)	FINAL CFM	% to design
1-1	105 COOKING	PSR	10	296	614	297	100.3
1-2	107 JANITOR	SR	10	296	490	311	105.1
1-3	105 COOKING	HOOD	8	130	211	134	103.1
1-4	105 COOKING	HOOD	8	130	211	134	103.1
1-5	105 COOKING	HOOD	8	130	211	134	103.1
1-6	105 COOKING	HOOD	8	130	211	134	103.1
1-7	105 COOKING	HOOD	8	130	211	134	103.1
1-8	104 SALES	SR	10	296	739	279	94.3
1-9	102 SEATING	SR	10	296	239	321	108.4
1-10	102 SEATING	SR	10	296	225	303	102.4
1-11	111 RR	SR	10	80	167	81	101.3
1-12	101 ORDER	SR	10	296	300	288	97.3
1-13	102 SEATING	SR	10	296	323	303	102.4
1-14	102 SEATING	SR	10	296	440	322	108.8
Total				3098	4592	3175	102.49%

Completed By: Zack Eismin on 12/11/2025

# National TAB

Project: Wingstop (Salinas, CA)

System/Unit: AHU/RTU



Asset: (E) A/C-2

AREA:106 PREP

Unit Data	
	Actual
MFG	RHEEM
Serial Num	F102503794
Model Num	RGECYB060ACU12BAA
Configuration	RTU
Num OA Filters 1	1
OA Filter Size 1	33X6
Num PreFilter 1	4
PreFilter Size 1	16X16X2

Motor Data	
	Actual
Motor MFG	PROTECH
Horsepower	1.5
Phase	1
Rated Voltage	208
Rated Amperage	11.5
Service Factor	1.0

Test Data		
	Design	Actual
SF CFM	2072	1966
RA CFM	1772	1655
OA CFM	300	311
RL Voltage	208	206
RL Amperage	11.5	9.5
OA Damper Position	-	16%
Brake Horse Power	-	1.23

Performance Data		
	Design	Actual
MA Plenum SP	-	-0.31"
Fan Suction SP	-	-0.53"
Fan Discharge SP	-	0.44"
Total ESP	-	0.75"
Fan Total SP	-	0.97"

Completed By: Zack Eismin on 12/11/2025

## Unit Data - PHOTO LOG



12/11/2025

# National TAB

Project:Wingstop (Salinas, CA)

## AHU/RTU



### Diffuser Supply (GRD)

#### (E) A/C-2/106 PREP

Asset							
Asset Name	Location	Type	Size	DESIGN CFM	CFM(1)	FINAL CFM	% to design
2-1	106 PREP	SR	10	296	216	276	93.2
2-2	106 PREP	SR	10	296	275	279	94.3
2-3	106 PREP	SR	10	296	266	281	94.9
2-4	106 PREP	SR	10	296	262	299	101.0
2-5	106 PREP	SR	10	296	185	277	93.6
2-6	105 COOKING	PSR	10	296	187	283	95.6
2-7	105 COOKING	SR	10	296	204	271	91.6
Total				2072	1595	1966	94.88%

# National TAB

Project: Wingstop (Salinas, CA)

## System/Unit: FAN - Supply



Asset: MUA-1

AREA:

Unit Data	
	Actual
<b>MFG</b>	ECON-AIR
<b>Model Num</b>	EA-A1-15D
<b>Serial Num</b>	7406279
<b>Type</b>	MAU
<b>Configuration</b>	VERTICAL
<b>Num Filters Size 1</b>	2
<b>Filter Size 1</b>	18X14

Motor Data	
	Actual
<b>Motor MFG</b>	TECO
<b>Frame</b>	145T
<b>Horsepower</b>	1.5
<b>Motor Rpm</b>	1740
<b>Phase</b>	3
<b>Voltage (rated)</b>	208
<b>Amperage (rated)</b>	4.02
<b>Service Factor</b>	1.15

Test Data		
	Design	Actual
<b>CFM</b>	1998	2023
<b>SF RPM</b>	1983	1537
<b>Motor Frequency</b>	-	53HZ
<b>SF System SetPt</b>	-	53HZ
<b>RL Voltage</b>	208	207/207/207
<b>RL Amperage</b>	4.4	3.6/3.6/3.6
<b>Suction ESP</b>	-	-0.27"
<b>Discharge ESP</b>	-	0.31"
<b>Total ESP</b>	0.50	0.58"
<b>Brake Horse Power</b>	-	1.32

Completed By: Zack Eismin on 12/11/2025

## Unit Data - PHOTO LOG



12/11/2025

# National TAB

Project: Wingstop (Salinas, CA)

## System/Unit: FAN - Exhaust



Asset: EF-1

AREA:111 RESTROOM

Unit Data	
	Actual
MFG	NL
Model Num	NL
Serial Num	NL
Type	CEILING

Test Data		
	Design	Actual
CFM	80	77
System SetPt	-	HIGH SPEED
Total ESP	-	0.21"

Motor Data	
	Actual
Phase	1
Voltage (rated)	115
Amperage (rated)	0.27
Service Factor	1.0

Completed By: Zack Eismin on 12/11/2025

**Unit Data - PHOTO LOG**



**12/11/2025**

# National TAB

Project: Wingstop (Salinas, CA)

## System/Unit: FAN - Exhaust



Asset: KEF-1

AREA:

Unit Data	
	Actual
MFG	ECON-AIR
Model Num	EADU180H
Serial Num	7406279
Type	CRE

Motor Data	
	Actual
Motor MFG	TECO
Frame	184T
Horsepower	2
Motor Rpm	1165
Phase	3
Voltage (rated)	208
Amperage (rated)	6.56
Service Factor	1.15

Test Data		
	Design	Actual
CFM	2475	2527
Motor Frequency	-	41.4HZ
System SetPt	-	41.4HZ
RL Voltage	208	207/207/207
RL Amperage	6.56	5.7/5.7/5.7
Suction ESP	-	-1.07"
Total ESP	1.20	1.07"
Brake Horse Power	-	1.74

Completed By: Zack Eismin on 12/11/2025

**Unit Data - PHOTO LOG**



**12/11/2025**

# National TAB

Project: Wingstop (Salinas, CA)

## System/Unit: Kitchen Hood Type I



Asset: HD-1

AREA:

Unit Data	
	Actual
MFG	ECON-AIR
Model Num	5430 EX-2
Job / Serial Num	7406279
Type	TYPE I CANOPY
Hood length	144"
Hood Width	54"
Supply Plenum Type	PSP
Supply Plenum Width	14"
Supply Plenum Length	156"

Test Data Exhaust	
	Actual
Filter Type	CAPTRATE SOLO
Filter Size 1	16X20
Filter Qty 1	9
Filter AK factor size 1	2.08
Filter Total AK Area	18.72
Filter1 FPM	121
Filter2 FPM	125
Filter3 FPM	139
Filter4 FPM	137
Filter5 FPM	156
Filter6 FPM	145
Filter7 FPM	137
Filter8 FPM	129
Filter9 FPM	132
Filter Ave FPM(corr)	135
CFM	2527

Cooking Equipment	
	Actual
Item 1	FRYERS

Test Data Supply		
	Design	Actual
Total Area	26.00	15.16
Kv factor (Vel)	-	0.89
Num of Readings	-	12
Reading1 FPM	-	162
Reading2 FPM	-	154
Reading3 FPM	-	169
Reading4 FPM	-	165
Reading5 FPM	-	120
Reading6 FPM	-	98
Reading7 FPM	-	156
Reading8 FPM	-	176
Reading9 FPM	-	175
Reading10 FPM	-	129
Reading11 FPM	-	159
Reading12 FPM	-	140
Ave FPM(corr)	-	150
CFM	1998	2023

Completed By: Zack Eismin on 12/11/2025

## Unit Data - PHOTO LOG



12/11/2025