

Arby's Restaurant Group Responsibilities Schedule						
Key notes:						
O/F: OWNER FURNISH (also includes work by owner's vendors)						
O/I: OWNER INSTALL (also includes work by owner's vendors)						
C/F: CONTRACTOR FURNISHED (includes contractor or subcontractors under his direction)						
C/I: CONTRACTOR INSTALLED (includes contractor or subcontractors under his direction)						
S: REQUIRES SUBMITTAL or SHOP DWG'S						
CATEGORY / TASK	O/F	O/I	C/F	C/I	S	COMMENTS/REMARKS
15000 MECHANICAL						
Roof top air conditioning units	x			x		Mechanical Sub- receive & install (Typical)
Roof top air conditioning curbs	x			x		Mechanical Sub- receive & install (Typical)
Roof top make up air units	x			x		Mechanical Sub- receive & install (Typical)
Roof top make up air curbs	x			x		Mechanical Sub- receive & install (Typical)
Roof top exhaust fans	x			x		Mechanical Sub- receive & install (Typical)
Roof top exhaust fan curbs	x			x		Mechanical Sub- receive & install (Typical)
Roof top condensers for cooler	x	x				Mechanical Sub- receive & install (Typical)
Roof top condensers for beverage dispensers	x			x		
Kitchen exhaust hoods	x			x		Mechanical Sub- receive & install (Typical)
Kitchen exhaust duct & insulation & fire wrap				x	x	
Restroom exhaust fan	x			x		
Air distribution ductwork				x	x	
Filter replacement prior to turnover				x	x	
Thermostats and Remote Sensors	x				x	
Control wiring				x	x	
Conduit for control wiring				x	x	
HVAC system start up				x	x	
Certified air balance/report	x	x				Coordinate with Owner

MECHANICAL LEGEND			
	SUPPLY DUCT UP		PIPING DOWN
	SUPPLY DUCT DOWN		PIPING UP
	RETURN DUCT UP		TURNING VANES
	RETURN DUCT DOWN		VOLUME DAMPER
	FIRE DAMPER		CONDENSATE DRAIN
	SMOKE DAMPER		MOTORIZED DAMPER
	COMB. FIRE/SMOKE DAMPER		BACKDRAFT DAMPER
	BACKDRAFT DAMPER		REMOTE ANNUNCIATOR
	SMOKE DETECTOR		REMOTE TEMP. SENSOR
	SPIN-IN WITH VOLUME DAMPER		THERMOSTAT
	45° RETURN DUCT TAP WITH VOL. DAMPER		FLEX DUCT
	DIFFUSER		LINEAR DIFFUSER WITH FLEX CONNECTION
	DIFFUSER WITH FLEX CONNECTION		ROUND DUCT UP
	GRILLE/REGISTER		ROUND DUCT DOWN
	SIDEWALL GRILLE/ REGISTER/ DIFFUSER		REDUCER
	CONNECT TO EXISTING		EXTENT OF DEMOLITION

SEQUENCE OF OPERATION	
A.	PROVIDE STAND ALONE OR APPLICATION SPECIFIC CONTROLLERS AS REQUIRED TO PERFORM THE FOLLOWING SEQUENCES OF OPERATIONS.
B.	PACKAGED ROOFTOP UNITS <ul style="list-style-type: none"> 1. UNIT SHALL CONSIST OF SUPPLY AIR FAN, FILTERS, DX COOLING COIL, GAS-FIRED HEAT SECTION, AND A 7-DAY PROGRAMMABLE THERMOSTAT. 2. PROVIDE AN OVERRIDE SWITCH TO OPERATE THE UNIT DURING UNOCCUPIED HOURS. THIS SWITCH SHALL BE PART OF THE PROGRAMMABLE THERMOSTAT. OVERRIDE SWITCH ALLOWS THE UNIT TO OPERATE FOR TWO HOURS (ADJUSTABLE). 3. OCCUPIED MODE: BASED ON THE ROOFTOP UNITS HOURS OF OCCUPANCY, START THE UNIT AT THE BEGINNING OF OCCUPANCY AND SHUT DOWN THE UNIT AT THE END OF OCCUPANCY (NOTE: OUTSIDE AIR DAMPER WITHIN THE RTU SHALL OPEN AND THEN THE RTU SHALL START). THE UNIT SHALL START EARLIER AS DETERMINED BY THE PROGRAM FOR EARLY WARM-UP OR COOL DOWN. ON A SYSTEM STARTUP, THE RTU FAN SHALL START AND RUN CONTINUOUSLY AND THE INTERNAL FACTORY CONTROLS SHALL BE ENABLED. BASED ON THE SPACE TEMPERATURE SENSOR, THE UNIT SHALL CYCLE THE HEATING/COOLING TO MAINTAIN THE SPACE TEMPERATURE SETPOINT. <ul style="list-style-type: none"> 3.1. ECONOMIZER MODE: WHEN ENTHALPY OF OA IS BELOW 28 BTU/LB, ECONOMIZER MODE SHALL BE ENABLED. ECONOMIZER MODE SHALL LINEARLY MODULATE OUTDOOR AIR CFM FROM MINIMUM OA CFM TO 100% BASED ON ENTHALPY READINGS. 4. UNOCCUPIED MODE: THE RTU INTERNAL OA DAMPERS SHALL REMAINED CLOSED WHEN THE BUILDING IS NOT OCCUPIED, THE RTU SHALL STOP HEATING/COOLING AND THE FAN SHALL STOP. IF THE SPACE TEMPERATURE FALLS BELOW 60 DEGREE F (ADJUSTABLE), THE UNIT SHALL START AND HEAT UNTIL THE SPACE TEMPERATURE IS 64 DEGREE F (ADJUSTABLE) AND THEN SHUTDOWN. IF THE SPACE TEMPERATURE RISES ABOVE 85 DEGREE F (ADJUSTABLE), THE UNIT SHALL START AND COOL UNTIL THE SPACE TEMPERATURE IS 80 DEGREE F (ADJUSTABLE) AND THEN SHUTDOWN. 5. UPON DETECTION OF SMOKE BY UNIT SMOKE DETECTOR THE RTU SHALL SHUT DOWN AND AN ALARM SHALL BE SENT TO THE RESPECTIVE LOCAL REMOTE ANNUNCIATORS.
C.	KITCHEN HOOD EXHAUST FAN (EF-1) <ul style="list-style-type: none"> 1. THE KITCHEN HOOD EXHAUST FAN SHALL BE ENABLED WHEN ANY COOKING APPLIANCE LOCATED UNDER THE HOOD IS IN USE.
D.	EF-2 <ul style="list-style-type: none"> 1. EXHAUST FAN SHALL RUN WHEN THE BUILDING IS OCCUPIED. EC TO WIRE THROUGH KITCHEN LIGHT SWITCH.
E.	ANSUL SYSTEM ACTIVATION <ul style="list-style-type: none"> 1. UPON ACTIVATION OF ANSUL SYSTEM, SHUT DOWN RTU-1 AND RTU-2. PROVIDE RELAYS CONTACTS, INTERLOCKS, TRANSFORMERS AND ALL ASSOCIATED WIRING TO ACCOMPLISH SEQUENCE. MECHANICAL CONTRACTOR SHALL INTERLOCK RTU-1 AND RTU-2 TO ALSO SHUT DOWN.

GENERAL NOTES:	
A.	ALL WORK TO BE PERFORMED TO MEET ALL STATE, CITY & LOCAL CODE REQUIREMENTS.
B.	ALL DUCTWORK TO BE CONSTRUCTED OF GALVANIZED METAL ACCORDING TO SMACMNA STANDARDS.
C.	ALL WALL PATCHING TO BE BY THE GENERAL CONTRACTOR.
D.	HVAC CONTRACTOR IS TO COORDINATE WITH OTHER TRADES BEFORE INSTALLING DUCTWORK. IF THE HVAC CONTRACTOR FAILS TO COORDINATE WITH OTHER TRADES AND THE WORK MUST BE ALTERED THE HVAC CONTRACTOR WILL CHANGE IT AT HIS OWN EXPENSE.
E.	ONCE THE SYSTEM IS COMPLETE AND ALL CEILING TILES ARE INSTALLED THE SYSTEM FILTER SHALL BE CHANGED AND THE AIR SIDE SHALL BE BALANCED. SUBMIT ELECTRONIC COPY OF BALANCE REPORT TO ENGINEER FOR REVIEW.
F.	COORDINATE THE EXACT LOCATION OF ALL GRILLES, REGISTERS & DIFFUSER WITH ARCHITECTURAL REFLECTED CEILING PLAN. ALSO COORDINATE MOUNTING HEIGHTS OF FIXTURES.
G.	HVAC CONTRACTOR IS TO VISIT THE SITE PRIOR TO SUBMITTING A BID & INCLUDE IN THE BID ANY ITEMS NECESSARY FOR A COMPLETE & OPERATIONAL SYSTEM.
H.	PROVIDE TURNING VANES AT ALL 90° CHANGE IN DIRECTION.
I.	DRAWINGS ARE SCHEMATIC IN NATURE & HVAC CONTRACTOR IS TO INCLUDE ANY ITEMS REQUIRED FOR A COMPLETE & OPERATIONAL SYSTEM WHETHER SHOWN OR NOT SHOWN ON THE DRAWINGS.
J.	HVAC CONTRACTOR TO FURNISH ALL PERMITS REQUIRED FOR HIS PORTION OF THE WORK.
K.	HVAC CONTRACTOR TO COORDINATE WITH ELECTRICAL CONTRACTOR CONCERNING ELECTRICAL REQUIREMENTS BEFORE ORDERING ANY EQUIPMENT.
L.	FLEXIBLE DUCTS SHALL BE WIREMOLD TYPE WGC, 1-1/2" INSULATION & RATED AT 10" W.C WITH A MAXIMUM LENGTH OF 5'-0".

ABBREVIATIONS			
(D)	DEMOLITION	FPI	FINS PER INCH
(E)	EXISTING	GTC	GENERAL TRADES CONTRACTOR
(F)	FUTURE	ID	INNER DIAMETER
(R)	(RELOCATE)	LAT	LEAVING AIR TEMPERATURE
AAV	AUTOMATIC AIR VENT	LWT	LEAVING WATER TEMPERATURE
AFF	ABOVE FINISHED FLOOR	MFR	MANUFACTURER
AMB	AMBIENT	N/A	NOT APPLICABLE
APD	AIR PRESSURE DROP	NC	NORMALLY CLOSED
BAS	BUILDING AUTOMATIC SYSTEM	NO	NORMALLY OPEN
BDD	BACKDRAFT DAMPER	NIS	NOT TO SCALE
BFF	BACKFLOW PREVENTER	OA	OUTSIDE AIR
BLDG	BUILDING	OD	OUTSIDE DIAMETER
BOB	BOTTOM OF BEAM	PD	PRESSURE DROP
BOD	BOTTOM OF DUCT	PRV	PRESSURE REDUCING VALVE
BOP	BOTTOM OF PIPE	RA	RETURN AIR
BOS	BOTTOM OF STRUCTURE	REL	RELIEF AIR
CL	CENTER LINE	SA	SUPPLY AIR
CO	CLEAN OUT	SCC	SENSIBLE COOLING CAPACITY
DB	DRY BULB	SP	STATIC PRESSURE
DIA	DIAMETER	TCP	TEMPERATURE CONTROL PANEL
DN	DOWN	TSP	TOTAL STATIC PRESSURE
EA	EXHAUST AIR	TYP	TYPICAL
EAT	ENTERING AIR TEMPERATURE	UNO	UNLESS NOTED OTHERWISE
EFF	EFFICIENCY	VFD	VARIABLE FREQUENCY DRIVE
EG	ETHYLENE GLYCOL	WB	WET BULB
ESP	EXTERNAL STATIC PRESSURE	WG	WATER GAUGE
EWT	ENTERING WATER TEMPERATURE	WPD	WATER PRESSURE DROP
EXH	EXHAUST		

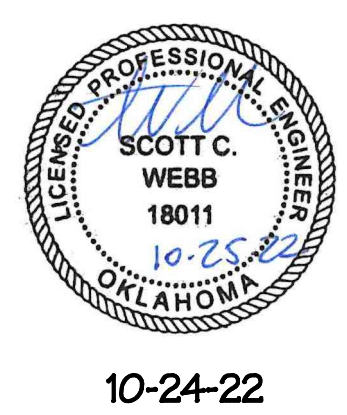

10-24-22

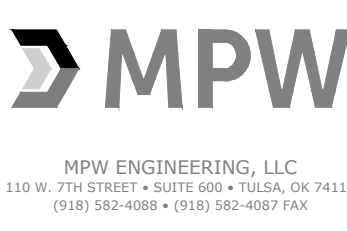

MPW ENGINEERING, LLC
1519 W. 7TH STREET • SUITE 404 • TULSA, OK 74119
(918) 582-4088 • (918) 582-4087 FAX



NEW RESTAURANT FOR:
ARBY'S - INSPIRE DUAL REG 40 - STD
 2010 SOUTH GREEN AVENUE
 PURCELL, OKLAHOMA 73080
 FOR
 RB AMERICAN GROUP
 6200 OAK TREE BLVD., INDEPENDENCE, OH 44131

PROJECT NUMBER:

ISSUE	DATE
PRELIMINARY	10-24-2022
REVISION	

GENERAL INFORMATION MECHANICAL

SHEET:

M0.0

DRAWING INDEX	
M0.0	GENERAL INFORMATION MECHANICAL
M1.1	FLOOR PLAN MECHANICAL
M3.1	ROOF PLAN MECHANICAL
M5.1	SCHEDULES MECHANICAL
M7.1	SPECIFICATIONS MECHANICAL
M7.2	SPECIFICATIONS MECHANICAL
H1.1	CAPTIVEAIRE DRAWING
H1.2	CAPTIVEAIRE DRAWING
H1.3	CAPTIVEAIRE DRAWING
H1.4	CAPTIVEAIRE DRAWING
H1.5	CAPTIVEAIRE DRAWING

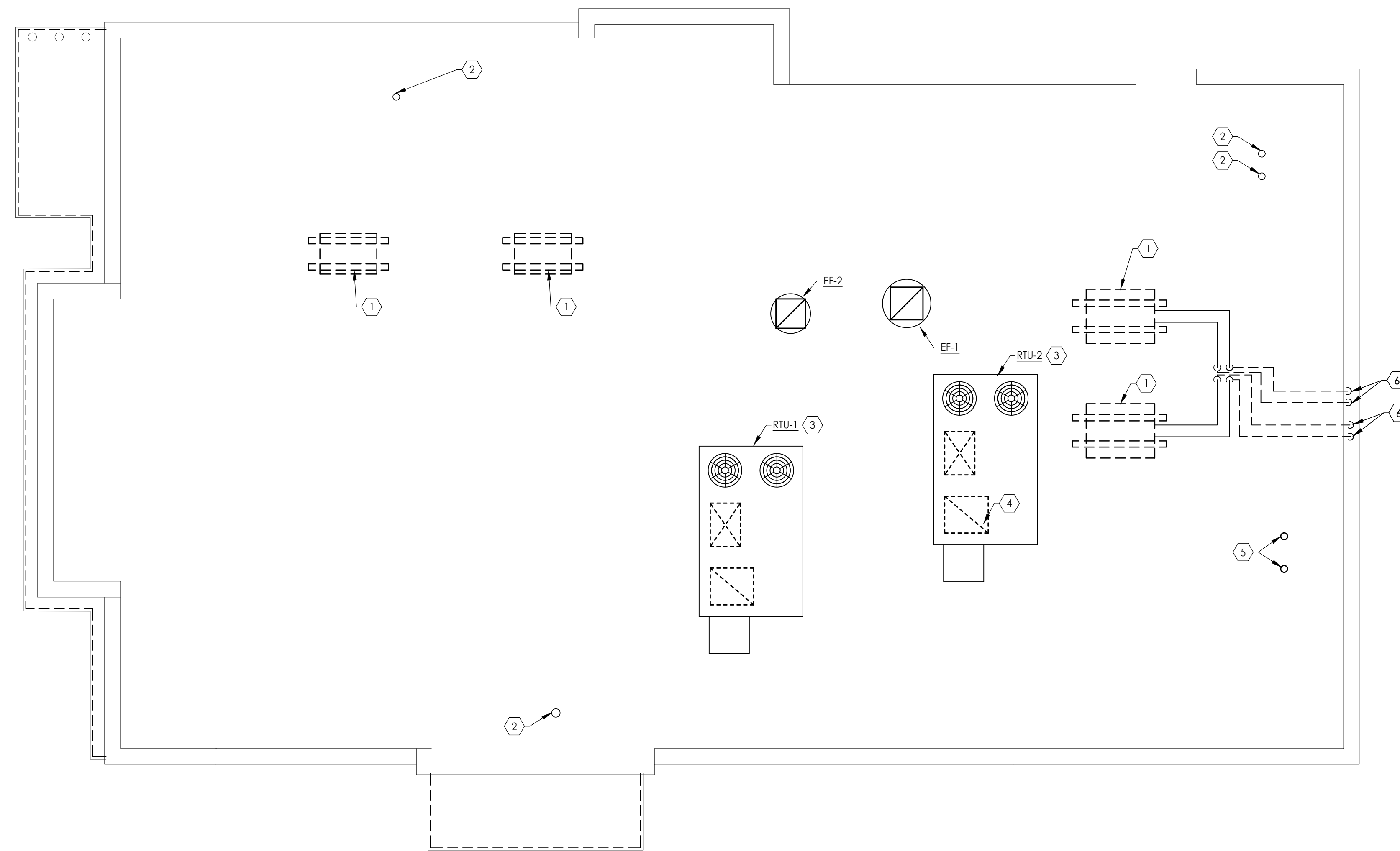

1
ROOF PLAN MECHANICAL
 1/4" = 1'-0"

GENERAL NOTES:

- A. MOUNT ALL HVAC EQUIPMENT ON ROOF PER DETAILS ON SHEET M5.1.
- B. CONTRACTOR TO MAINTAIN MINIMUM MANUFACTURER RECOMMENDED SERVICE CLEARANCE AROUND EACH PIECE OF EQUIPMENT.
- C. CONTRACTOR TO ENSURE A MINIMUM OF 10' CLEARANCE BETWEEN ALL OA INTAKES AND ANY EXHAUST FANS, VENTS, FLUES, ETC.
- D. CONTRACTOR TO ENSURE ALL MECHANICAL EQUIPMENT IS INSTALLED A MINIMUM OF 10' FROM THE ROOF EDGE.
- E. COORDINATE EXHAUST LOCATION OF RTUS WITH STRUCTURE TO ENSURE DUCT DROPS ARE LOCATED WITHIN TRUSS.

CODED NOTES: 

1. CONDENSING UNIT SHOWN FOR REFERENCE ONLY. EQUIPMENT AND ASSOCIATED REFRIGERANT PIPING TO BE INSTALLED BY KITCHEN EQUIPMENT SUPPLIER.
2. PLUMBING VENT/ FLUE PIPING SHOWN FOR REFERENCE. MAINTAIN A MINIMUM OF 10'-0" CLEARANCE TO ANY OA INTAKE.
3. RTUS MOUNTED ON CURB ON ROOF. REFER TO DETAIL ON SHEET M5.1 FOR FURTHER INFORMATION.
4. WATER HEATER FLUE PENETRATIONS SHOWN FOR REFERENCE.
5. WALK-IN COOLER VENDOR TO PROVIDE REFRIGERANT LINES FROM ROOF MOUNTED CONDENSING UNITS TO EVAPORATORS IN WALK-IN COOLERS. WALK-IN COOLER VENDOR TO ROUTE THRU PREFABRICATED ROOF CURB TO ABOVE THE CEILING AND DOWN THRU FURRED OUT WALL INTO THE WIC BOX. COORDINATE EXACT LOCATIONS WITH G.C. PRIOR TO INSTALLATION. G.C. TO PROVIDE SLEEVE IN WALL FROM WALK-IN COOLER ROOF UP TO CEILING SPACE ABOVE KITCHEN. REFER TO ARCHITECTURAL WALL SECTIONS.



10-24-22



MPW ENGINEERING, LLC
 110 W. 7TH STREET • SUITE 600 • TULSA, OK 74119
 (918) 582-4088 • (918) 582-4087 FAX



NEW RESTAURANT FOR:
ARBY'S - INSPIRE DUAL REG 40 - STD
 2010 SOUTH GREEN AVENUE
 PURCELL, OKLAHOMA 73080
 FOR
 RB AMERICAN GROUP
 6200 OAK TREE BLVD., INDEPENDENCE, OH 44131

PROJECT NUMBER:

ISSUE	DATE
PRELIMINARY	10-24-2022

REVISION

ROOF PLAN MECHANICAL

SHEET:

M3.1

PACKAGED ROOFTOP UNIT SCHEDULE																							
BASED ON LENNOX U.N.O.																							
UNIT DATA			PERFORMANCE DATA						COOLING DATA				HEATING DATA				ELECTRICAL DATA						
TAG	MODEL	FUNCTION	NOMINAL TONS	EFFICIENCY (EER)	TOTAL CFM	MIN. OA CFM	ESP (IN. WC)	TSP (IN. WC)	SUPPLY FAN (HP)	TOTAL MBH	SENSIBLE MBH	E.A.T (°F) DB/WB	REFRIG.	INPUT (MBH)	OUTPUT (MBH)	ΔT (°F)	FUEL TYPE	VOLT	PH	MCA	MOCP	RTU WEIGHT	COMMENTS
RTU-1	LGT092H4E-Y	DINING AREA	7.5	12.3	3000	850	1.0"	1.35"	3.8	89.8	73.3	82.3° / 66.3°	R410-A	180	144	44.4°	LP	208	3	43	50	1365	1-4
RTU-2	LGT092H4E-Y	KITCHEN AREA	7.5	12.3	3000	850	1.0"	1.35"	3.8	89.8	73.3	82.3° / 66.3°	R410-A	180	144	44.4°	LP	208	3	43	50	1365	1-4

COMMENTS: 1. HAIL GUARD
2. 14" ROOF CURB
3. FACTORY PROVIDED DISCONNECT
4. FACTORY PROVIDED ENTHALPY ECONOMIZER WITH POWERED EXHAUST
5. INSTALL LP CONVERSION KIT PER MANUFACTURER RECOMMENDATION.

GRILLES, REGISTERS, AND DIFFUSERS SCHEDULE									
BASED ON TITUS U.N.O.									
UNIT DATA		PERFORMANCE DATA						COMMENTS	
TAG	FUNCTION	MODEL	FACE SIZE	FRAME TYPE	MATERIAL	FINISH	BALANCE DAMPER	MAX N.C.	COMMENTS
D1	SUPPLY	TMS	24" x 24"	LAY-IN	STEEL	WHITE	-	25	
D2	SUPPLY	TMS	24" x 24"	LAY-IN	STEEL	WHITE	-	25	
G1	EXHAUST	50F	12" x 12"	LAY-IN	ALUMINUM	WHITE	-	25	
G2	RETURN	350RL	24" x 24"	LAY-IN	STEEL	WHITE	-	25	

NOTES: 1. ALL SUPPLY DIFFUSERS TO BE INSULATED VIA FACTORY SYSTEM.

KITCHEN HOOD SCHEDULE											
BASED ON CAPTIVEAIRE U.N.O.											
UNIT DATA			PERFORMANCE DATA					LIGHTS			MISC.
TAG	MODEL	HOOD LENGTH	MAX. COOKING TEMP.	TOTAL EXHAUST CFM	RISER (W" x L")	S.P. (IN" W.G.)	QTY.	TYPE	FIRE SUPP. SYSTEM	HANGING WEIGHT (LBS.)	COMMENTS
KH-1	5424-ND-2	5'-0"	450°F	1000	-	-0.36	3	RECESSED ROUND	YES	476	

EXHAUST FAN SCHEDULE												
BASED ON CAPTIVEAIRE U.N.O.												
UNIT DATA			PERFORMANCE DATA					MOTOR DATA				
TAG	MODEL	FUNCTION	FAN TYPE	CFM	ESP	RPM	DAMPER	BELT OR DIRECT	HP	VOLT	PH	COMMENTS
EF-1	DU50HFA	KH-1 HOOD EXHAUST	ROOF MOUNTED UP BLAST	1000	0.75	1370	-	DIRECT	1/2	115	1	1,2
EF-2	DR12HFA	RESTROOM EXHAUST	ROOF MOUNTED DOWN BLAST	300	0.25	1003	YES	DIRECT	1/4	115	1	1,2

NOTES: 1. FACTORY PROVIDED DISCONNECT SWITCH
2. REFER TO CAPTIVEAIRE DRAWINGS FOR ROOF CURB

VENTILATION SCHEDULE												
BASED ON IMC 2011												
SPACE DATA			PEOPLE VENTILATION			AREA VENTILATION			TOTAL			
SPACE NAME	ROOM NUMBER	CATEGORY	RTU SERVED BY	OCC.	CFM PER PERSON	CFM TOTAL (PEOPLE)	AREA (SF)	CFM REQUIRED PER SF	CFM TOTAL (AREA)	TOTAL VENTILATION	ROOFTOP UNIT VENTILATION SUMMATION	
DINING	102	FOOD & BEVERAGE/DINING	RTU-1	40	7.5	300	1000	0.18	180	480		
VESTIBULE (S)	100	CORRIDORS	RTU-1	-	-	0	38	0.18	7	7		
VESTIBULE (N)	101	CORRIDORS	RTU-1	-	-	0	50	0.18	9	9		
WOMENS	103	RESTROOMS	RTU-1	-	-	-	-	-	-	-		
MENS	104	RESTROOMS	RTU-1	-	-	-	-	-	-	-		
UNLISTED ROOMS ARE LUMPED INTO LISTED ROOMS										496		
										SYSTEM EFFICIENCY	CORRECTED OA	OA PROVIDED
										0.8	620	850

VENTILATION SCHEDULE												
BASED ON IMC 2011												
SPACE DATA			PEOPLE VENTILATION			AREA VENTILATION			TOTAL			
SPACE NAME	ROOM NUMBER	CATEGORY	RTU SERVED BY	OCC.	CFM PER PERSON	CFM TOTAL (PEOPLE)	AREA (SF)	CFM REQUIRED PER SF	CFM TOTAL (AREA)	TOTAL VENTILATION	ROOFTOP UNIT VENTILATION SUMMATION	
SERVICE AREA	104	FOOD & BEVERAGE/KITCHEN	RTU-2	10	7.5	75	350	0.18	63	138		
KITCHEN	106	FOOD & BEVERAGE/KITCHEN	RTU-2	2	7.5	15	500	0.18	90	90		
UNLISTED ROOMS ARE LUMPED INTO LISTED ROOMS										228		
										SYSTEM EFFICIENCY	CORRECTED OA	OA PROVIDED
										0.8	285	850

AIR BALANCE SCHEDULE					
COMPONENT	SUPPLY CFM	RETURN CFM	SUPPLY AIR CFM TO HOOD	OUTDOOR AIR CFM	EXHAUST CFM
RTU-1	3000	2150	-	850	-
RTU-2	3000	2150	-	850	-
EF-1	-	-	-	-	1000
EF-2	-	-	-	-	300
TOTAL	6000	4300	0	1700	+ 400 CFM

BUILDING PRESSURE

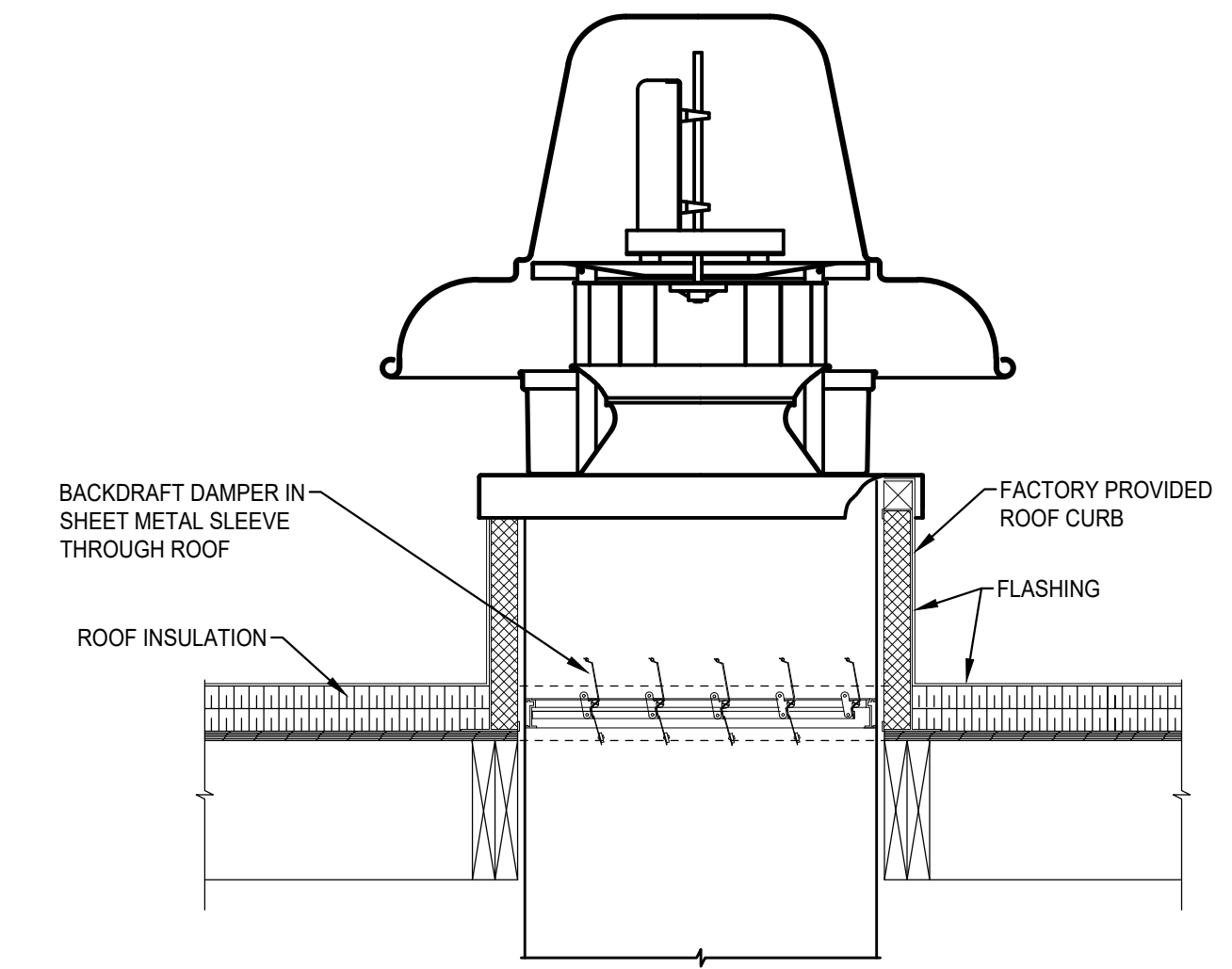

2 GENERAL EXHAUST FAN DETAIL
N.T.S.

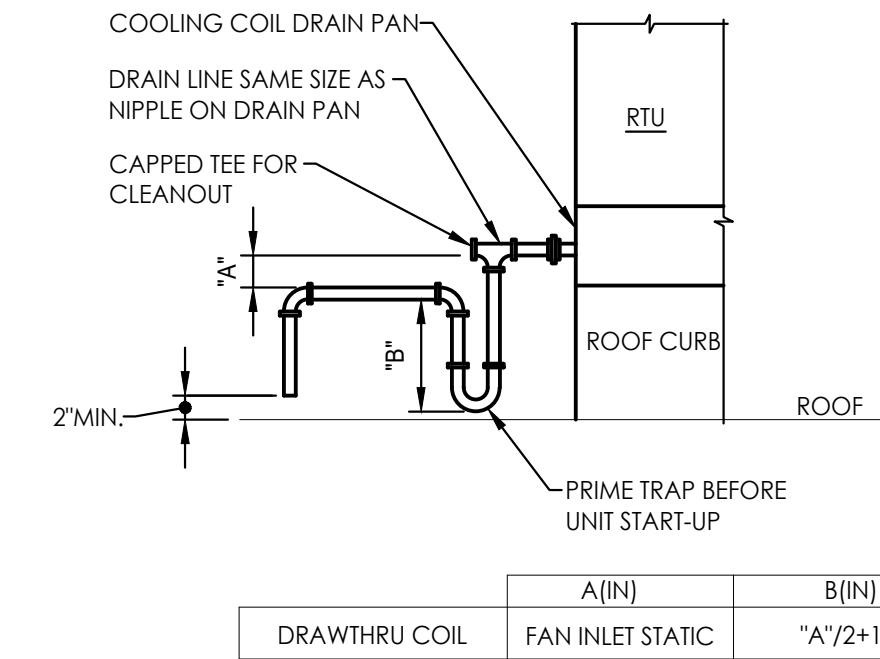

1 RTU CONDENSATE DRAIN DETAIL
N.T.S.

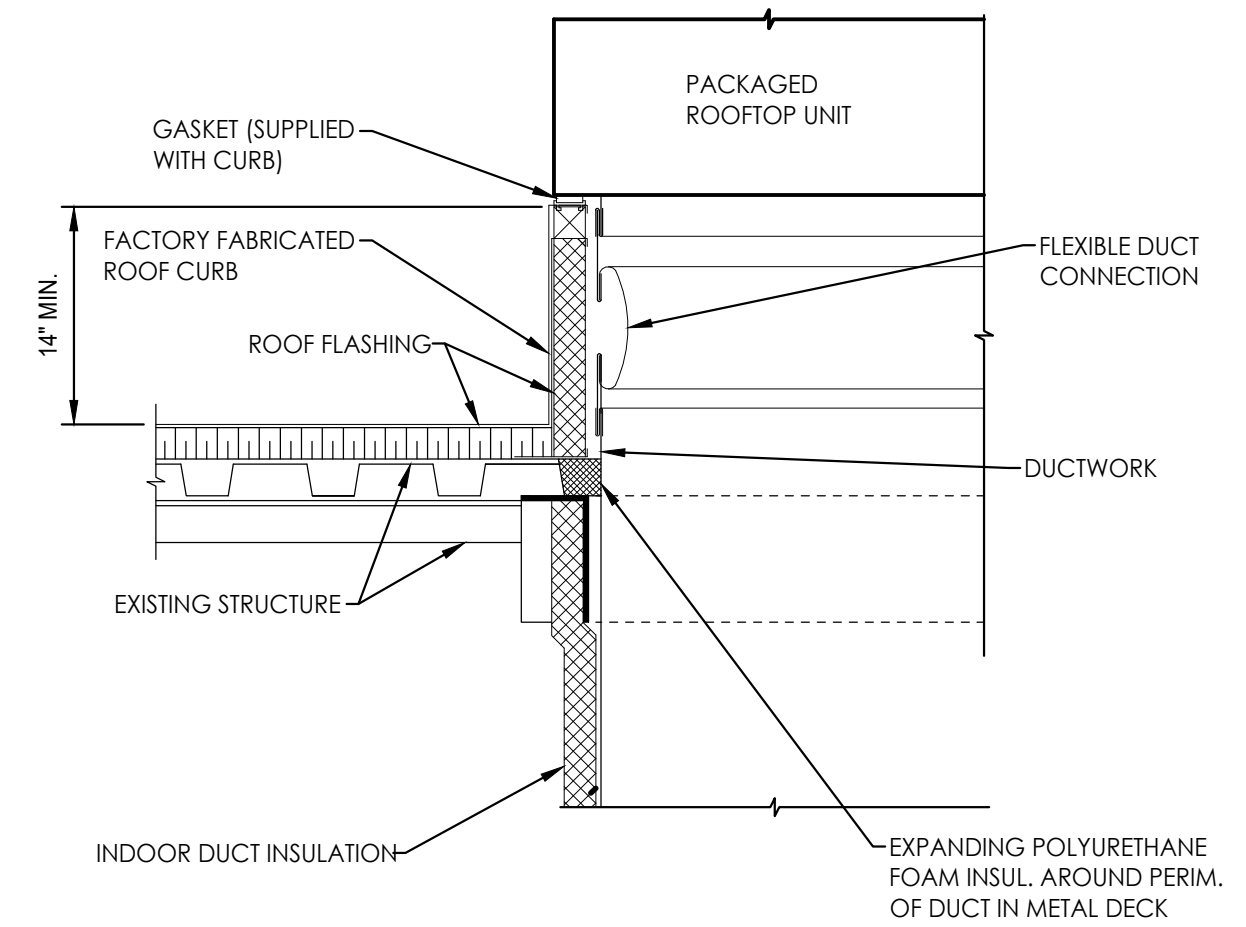

NOTES:
1. IN-FILL BETWEEN EQUIPMENT CURB AND DUCTWORK, ALL SIDES WITH BATT. INSULATION (TYP.).

3 PACKAGED ROOFTOP UNIT DETAIL
N.T.S.

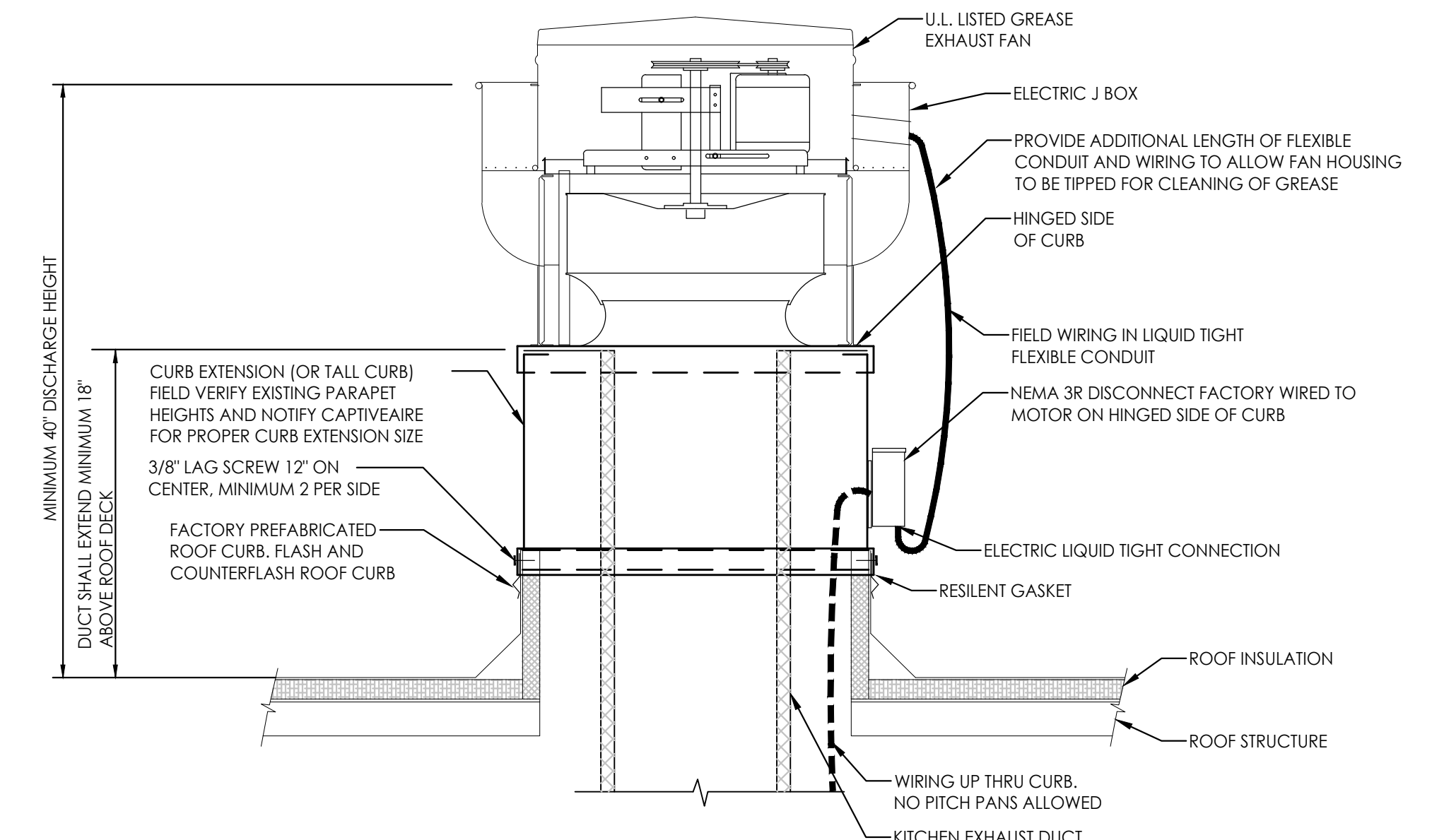

NOTES:

- INSTALLATION SHALL BE IN ACCORDANCE WITH NFPA 96 REQUIREMENTS.
- CUT AND PATCH EXISTING ROOFING AS REQUIRED FOR NEW CURB INSTALLATION.
- CURB SHALL BE TAPERED TYPE AND MATCH THE PITCH OF THE ROOF.
- CONTRACTOR TO PROVIDE TREATED WOOD BLOCKINGS AND SHIM FLAT ROOF CURB TILL LEVEL FOR ALL EXHAUST FANS AND TO ACHIEVE ROOF CURB HEIGHTS. PROVIDE ROOF CURB EXTENSION IF REQUIRED.

4 GREASE EXHAUST FAN DETAIL
N.T.S.



10-24-22



MPW ENGINEERING, LLC
110 W. 7TH STREET • SUITE 600 • TULSA, OK 74119
(918) 582-4088 • (918) 582-4087 FAX



NEW RESTAURANT FOR:
ARBY'S - INSPIRE DUAL REG 40 - STD
2010 SOUTH GREEN AVENUE
PURCELL, OKLAHOMA 73080
FOR
RB AMERICAN GROUP
6200 OAK TREE BLVD., INDEPENDENCE, OH 44131

PROJECT NUMBER:

ISSUE DATE
PRELIMINARY 10-24-2022

REVISION

SCHEDULES
MECHANICAL

SHEET:

M5.1

SPECIFICATIONS - DIVISION 23 - HVAC

GENERAL MECHANICAL REQUIREMENTS:

HVAC SUBCONTRACTOR SHALL PROVIDE AT BID TIME A BID TO PROVIDE PREVENTATIVE MAINTENANCE SERVICES FOR ONE YEAR.

FURNISH TO THE OWNER ALL OPERATING & MAINTENANCE MANUALS, RECORD DRAWINGS, TEST & BALANCE REPORT, CONTRACTOR SHALL COORDINATE WITH MANUFACTURER REPRESENTATIVES FOR EMPLOYEE TRAINING REQUIREMENTS FOR ALL EQUIPMENT.

MECHANICAL CONTRACTOR SHALL SUBMIT COMPLIANCE CHECKLIST TO BUILDING OFFICIAL UPON SUBSTANTIAL COMPLETION OF PROJECT. PROVIDE EQUIPMENT INDICATED ON THE DRAWINGS, AND AS REQUIRED FOR A COMPLETE FUNCTIONING SYSTEM.

DEFINITIONS:

FURNISH MEANS TO SUPPLY AND DELIVER TO PROJECT SITE, READY FOR INSTALLATION.
INSTALL MEANS TO PLACE IN POSITION AND MAKE CONNECTIONS FOR SERVICE OR USE.
PROVIDE MEANS TO FURNISH AND INSTALL, COMPLETE AND READY FOR INTENDED USE.

WARRANTY:

PROVIDE LABOR AND MATERIALS TO REPAIR OR REPLACE DEFECTIVE PARTS AND MATERIALS AS REQUIRED FOR ONE YEAR AFTER SUBSTANTIAL COMPLETION OR OWNER ACCEPTANCE OF THE COMPLETED PROJECT. PROVIDE A SEPARATE LINE ITEM DEDUCT AMOUNT ON THE PROPOSAL FORM TO DELETE WARRANTY SERVICE, AT THE OWNER'S OPTION. CONTRACTOR SHALL INCLUDE ONE YEAR WARRANTY ON OWNER FURNISHED EQUIPMENT. CONTRACTOR SHALL INCLUDE COSTS FOR RECEIVING, HANDLING, STORAGE, AND HOISTING OF OWNER FURNISHED EQUIPMENT.

PROVIDE OPERATION MANUALS, MAINTENANCE MANUALS AND SCHEMATICS FOR ALL MECHANICAL EQUIPMENT INSTALLED.

COORDINATION:

COORDINATE WITH THE WORK OF OTHER SECTIONS, EQUIPMENT FURNISHED BY OTHERS, REQUIREMENTS OF THE OWNER, AND WITH THE CONSTRAINTS OF THE EXISTING CONDITIONS OF THE PROJECT SITE.

DUCT DIMENSIONS:

UNLESS OTHERWISE NOTED, DUCT DIMENSIONS ON THE DRAWINGS ARE INSIDE CLEAR DIMENSIONS.

TEMPERATURE CONTROLS:

PROVIDE PROGRAMMABLE THERMOSTATS WITH REMOTE TEMPERATURE SENSORS AND REMOTE HUMIDISTS COMPATIBLE WITH ROOFTOP UNIT. CONTROL WIRING SHALL BE INSTALLED IN CONDUIT. THERMOSTAT SHALL MEET SETPOINT ADJUSTMENT FOR UNOCCUPIED MODE: HEATING DOWN TO 55 DEGREES AND COOLING UP TO 85 DEGREES. PROVIDE INTERLOCK CONTROL WIRING BETWEEN HOOD EXHAUST FANS AND ROOFTOP UNITS.

END OF SECTION

SECTION 230593 - TESTING, ADJUSTING, AND BALANCING FOR HVAC

PART 1 - GENERAL

1.1 SECTION REQUIREMENTS

A. SUBMITTALS:

- CERTIFIED TAB REPORTS.
- TAB FIRM QUALIFICATIONS: AABC NEBB OR TABB CERTIFIED.
- TAB REPORT FORMS: STANDARD TAB CONTRACTOR'S FORMS APPROVED BY ARCHITECT.
- PERFORM TAB AFTER LEAKAGE AND PRESSURE TESTS ON AIR DISTRIBUTION SYSTEMS HAVE BEEN SATISFACTORILY COMPLETED.

PART 2 - PRODUCTS (NOT USED)

PART 3 - EXECUTION

3.1 EXAMINATION

- EXAMINE THE CONTRACT DOCUMENTS TO BECOME FAMILIAR WITH PROJECT REQUIREMENTS AND TO DISCOVER CONDITIONS IN SYSTEMS' DESIGNS THAT MAY PRECLUDE PROPER TAB OF SYSTEMS AND EQUIPMENT.
- EXAMINE THE APPROVED SUBMITTALS FOR HVAC SYSTEMS AND EQUIPMENT.
- EXAMINE SYSTEMS FOR INSTALLED BALANCING DEVICES, SUCH AS TEST PORTS, GAGE COCKS, THERMOMETER WELLS, FLOW-CONTROL DEVICES, BALANCING VALVES AND FITTINGS, AND MANUAL VOLUME DAMPERS. VERIFY THAT LOCATIONS OF THESE BALANCING DEVICES ARE ACCESSIBLE.
- EXAMINE SYSTEM AND EQUIPMENT INSTALLATIONS AND VERIFY THAT FIELD QUALITY-CONTROL TESTING, CLEANING, AND ADJUSTING SPECIFIED IN INDIVIDUAL SECTIONS HAVE BEEN PERFORMED.
- EXAMINE HVAC EQUIPMENT AND FILTERS AND VERIFY THAT BEARINGS ARE GREASED, BELTS ARE ALIGNED AND TIGHT, AND EQUIPMENT WITH FUNCTIONING CONTROLS IS READY FOR OPERATION.
- EXAMINE TERMINAL UNITS, SUCH AS VARIABLE-AIR-VOLUME BOXES, AND VERIFY THAT THEY ARE ACCESSIBLE AND THEIR CONTROLS ARE CONNECTED AND FUNCTIONING.
- EXAMINE AUTOMATIC TEMPERATURE SYSTEM COMPONENTS TO VERIFY THE FOLLOWING:
 - DAMPERS, VALVES, AND OTHER CONTROLLED DEVICES ARE OPERATED BY THE INTENDED CONTROLLER.
 - DAMPERS AND VALVES ARE IN THE POSITION INDICATED BY THE CONTROLLER.
 - INTEGRITY OF DAMPERS AND VALVES FOR FREE AND FULL OPERATION AND FOR TIGHTNESS OF FULLY CLOSED AND FULLY OPEN POSITIONS. THIS INCLUDES DAMPERS IN MULTIZONE UNITS, MIXING BOXES, AND VARIABLE-AIR-VOLUME TERMINALS.
 - AUTOMATIC MODULATING AND SHUTOFF VALVES, INCLUDING TWO-WAY VALVES AND THREE-WAY MIXING AND DIVERTING VALVES, ARE PROPERLY CONNECTED.
 - THERMOSTATS AND HUMIDISTS ARE LOCATED TO AVOID ADVERSE EFFECTS OF SUNLIGHT, DRAFTS, AND COLD WALLS.
 - SENSORS ARE LOCATED TO SENSE ONLY THE INTENDED CONDITIONS.
 - SEQUENCE OF OPERATION FOR CONTROL MODES IS ACCORDING TO THE CONTRACT DOCUMENTS.
 - CONTROLLER SET POINTS ARE SET AT INDICATED VALUES.
 - INTERLOCKED SYSTEMS ARE OPERATING.
 - CHANGEOVER FROM HEATING TO COOLING MODE OCCURS ACCORDING TO INDICATED VALUES.
- REPORT DEFICIENCIES DISCOVERED BEFORE AND DURING PERFORMANCE OF TEST AND BALANCE PROCEDURES.

3.2 GENERAL PROCEDURES FOR TESTING AND BALANCING

- PERFORM TESTING AND BALANCING PROCEDURES ON EACH SYSTEM ACCORDING TO THE PROCEDURES CONTAINED IN AABC'S "NATIONAL STANDARDS FOR TOTAL SYSTEM BALANCE", ASHRAE 111, NEBB'S "PROCEDURAL STANDARDS FOR TESTING, ADJUSTING, AND BALANCING OF ENVIRONMENTAL SYSTEMS" OR SMACNA'S "HVAC SYSTEMS - TESTING, ADJUSTING, AND BALANCING" AND IN THIS SECTION.
- CUT INSULATION, DUCTS, PIPES, AND EQUIPMENT CABINETS FOR INSTALLATION OF TEST PROBES TO THE MINIMUM EXTENT NECESSARY FOR TAB PROCEDURES. AFTER TESTING AND BALANCING, PATCH PROBE HOLES IN DUCTS WITH SAME MATERIAL AND THICKNESS AS USED TO CONSTRUCT DUCTS. INSTALL AND JOIN NEW INSULATION THAT MATCHES REMOVED MATERIALS. RESTORE INSULATION, COVERINGS, VAPOR BARRIER, AND FINISH.
- MARK EQUIPMENT AND BALANCING DEVICES, INCLUDING DAMPER-CONTROL POSITIONS, VALVE POSITION INDICATORS, FAN-SPEED-CONTROL LEVERS, AND SIMILAR CONTROLS AND DEVICES, WITH PAINT OR OTHER SUITABLE, PERMANENT IDENTIFICATION MATERIAL TO SHOW FINAL SETTINGS.

3.3 GENERAL PROCEDURES FOR BALANCING AIR SYSTEMS

- PREPARE SCHEMATIC DIAGRAMS OF SYSTEMS "AS-BUILT" DUCT LAYOUTS.
- FOR VARIABLE-AIR-VOLUME SYSTEMS, DEVELOP A PLAN TO SIMULATE DIVERSITY.
- DETERMINE THE BEST LOCATIONS IN MAIN AND BRANCH DUCTS FOR ACCURATE DUCT AIRFLOW MEASUREMENTS.
- VERIFY THAT MOTOR STARTERS ARE EQUIPPED WITH PROPERLY SIZED THERMAL PROTECTION.
- CHECK FOR AIRFLOW BLOCKAGES.
- CHECK CONDENSATE DRAINS FOR PROPER CONNECTIONS AND FUNCTIONING.

- CHECK FOR PROPER SEALING OF AIR-HANDLING UNIT COMPONENTS.
- CHECK FOR PROPER SEALING OF AIR DUCT SYSTEM.

3.4 TOLERANCES

- SET HVAC SYSTEM AIRFLOW AND WATER FLOW RATES WITHIN THE FOLLOWING TOLERANCES:
 - SUPPLY, RETURN, AND EXHAUST FANS AND EQUIPMENT WITH FANS: PLUS OR MINUS 10 PERCENT.
 - AIR OUTLETS AND INLETS: PLUS OR MINUS 10 PERCENT.

END OF SECTION 230593

SECTION 230700 - HVAC INSULATION

PART 2 - PRODUCTS

2.1 PERFORMANCE REQUIREMENTS

A. SURFACE-BURNING CHARACTERISTICS:

- INDOOR INSULATION AND RELATED MATERIALS: TO BE FACTORY LABELED DESIGNATING MAXIMUM FLAME-SPREAD INDEX OF 25 OR LESS, AND SMOKE-DEVELOPED INDEX OF 50 OR LESS ACCORDING TO ASTM E 84.

2.2 INSULATION MATERIALS

- FLEXIBLE ELASTOMERIC: CLOSED-CELL, SPONGE-OR EXPANDED-RUBBER MATERIALS. COMPLY WITH ASTM C 534.

TYPE I FOR TUBULAR MATERIALS AND TYPE II FOR SHEET MATERIALS.

F. MINERAL-FIBER BLANKET INSULATION: COMPLY WITH ASTM C 553, TYPE II AND ASTM C 1290, TYPE I.

- FSK JACKET: ALUMINUM-FOIL, FIBERGLASS-REINFORCED SCRIM WITH KRAFT-PAPER BACKING; COMPLYING WITH ASTM C 1136, TYPE II.

2. FSK TAPE: FOIL-FACE, VAPOR-RETARDER TAPE MATCHING FACTORY-APPLIED JACKET WITH ACRYLIC ADHESIVE:

COMPLYING WITH ASTM C 1136.

- MINERAL-FIBER, PIPE AND TANK INSULATION: COMPLYING WITH ASTM C 1393, TYPE II OR TYPE IIIA CATEGORY 2, OR WITH PROPERTIES SIMILAR TO ASTM C 612, TYPE IB; AND HAVING FACTORY-APPLIED ASJ JACKET. NOMINAL DENSITY IS 2.5 LB./CU. FT. OR MORE. THERMAL CONDUCTIVITY (K-VALUE) AT 100 DEG F IS 0.29 BTU X IN./H X SQ. FT. X DEG F OR LESS.

- ASJ: WHITE, KRAFT-PAPER, FIBERGLASS-REINFORCED SCRIM WITH ALUMINUM-FOIL BACKING; COMPLYING WITH ASTM C 1136, TYPE I.

- ASJ TAPE: WHITE VAPOR-RETARDER TAPE MATCHING FACTORY-APPLIED JACKET WITH ACRYLIC ADHESIVE,

COMPLYING WITH ASTM C 1136.

- FLEXIBLE ELASTOMERIC ADHESIVE: COMPLY WITH MIL-A-24179A, TYPE II, CLASS I.

- MINERAL-FIBER ADHESIVE: COMPLY WITH MIL-A-3316C, CLASS 2, GRADE A.

- VAPOR-BARRIER MASTIC: WATER BASED; SUITABLE FOR INDOOR AND OUTDOOR USE ON BELOW AMBIENT

SERVICES; COMPLY WITH MIL-PRF-19565C, TYPE II.

PART 3 - EXECUTION

3.1 INSULATION INSTALLATION

- COMPLY WITH REQUIREMENTS OF THE MIDWEST INSULATION CONTRACTORS ASSOCIATION'S "NATIONAL COMMERCIAL & INDUSTRIAL INSULATION STANDARDS" FOR INSULATION INSTALLATION ON PIPES AND EQUIPMENT.
- INSULATION INSTALLATION AT INTERIOR WALL AND PARTITION PENETRATIONS (THAT ARE NOT FIRE RATED): INSTALL INSULATION CONTINUOUSLY THROUGH WALLS AND PARTITIONS.

- INSULATION INSTALLATION AT FIRE-RATED WALL, PARTITION, AND FLOOR PENETRATIONS: INSTALL INSULATION CONTINUOUSLY THROUGH PENETRATIONS. SEAL PENETRATIONS. COMPLY WITH REQUIREMENTS IN SECTION 07B400.

D. FLEXIBLE ELASTOMERIC INSULATION INSTALLATION:

- SEAL LONGITUDINAL SEAMS AND END JOINTS WITH ADHESIVE TO ELIMINATE OPENINGS IN INSULATION THAT ALLOW PASSAGE OF AIR TO SURFACE BEING INSULATED.

- INSULATION INSTALLATION ON PIPE FITTINGS AND ELBOWS: INSTALL MITERED SECTIONS OF PIPE INSULATION. SECURE INSULATION MATERIALS AND SEAL SEAMS WITH ADHESIVE TO ELIMINATE OPENINGS IN INSULATION THAT ALLOW PASSAGE OF AIR TO SURFACE BEING INSULATED.

E. MINERAL-FIBER INSULATION INSTALLATION:

- INSULATION INSTALLATION ON STRAIGHT PIPES AND TUBES: WHERE VAPOR BARRIERS ARE INDICATED, SEAL LONGITUDINAL SEAMS, END JOINTS, AND PROTRUSIONS WITH VAPOR-BARRIER MASTIC AND JOINT SEALANT.
- FOR INSULATION WITH FACTORY-APPLIED JACKETS ON ABOVE AMBIENT SURFACES, SECURE LAPS WITH OUTWARD CLINCHED STAPLES AT 6 INCHES O.C.

- FOR INSULATION WITH FACTORY-APPLIED JACKETS ON BELOW AMBIENT SURFACES, DO NOT STAPLE LONGITUDINAL TABS BUT SECURE TABS WITH ADDITIONAL ADHESIVE AS RECOMMENDED BY INSULATION MATERIAL MANUFACTURER AND SEAL WITH VAPOR-BARRIER MASTIC AND FLASHING SEALANT.

- BLANKET INSULATION INSTALLATION ON DUCTS AND PLENUMS: SECURE WITH ADHESIVE AND INSULATION PINS.
- FOR DUCTS AND PLENUMS WITH SURFACE TEMPERATURES BELOW AMBIENT, INSTALL A CONTINUOUS UNBROKEN VAPOR BARRIER.

F. PLENUMS AND DUCTS REQUIRING INSULATION:

- CONCEALED SUPPLY AIR.
- CONCEALED AND EXPOSED OUTDOOR AIR.
- CONCEALED AND EXPOSED RETURN AIR LOCATED IN NONCONDITIONED SPACE.

3.2 DUCT AND PLENUM INSULATION SCHEDULE

RETAIN "ONE OF" OPTION IN PARAGRAPHS IN THIS ARTICLE TO ALLOW CONTRACTOR TO SELECT PIPING MATERIALS FROM THOSE RETAINED.

- CONCEALED DUCT INSULATION SHALL BE 1-1/2" THICK MINERAL-FIBER BLANKET WITH A 1.5-LB./CU. FT. NOMINAL DENSITY.

3.3 HVAC PIPING INSULATION SCHEDULE

- CONDENSATE PIPING: INSULATION SHALL BE 1" THICK FLEXIBLE ELASTOMERIC.

- REFRIGERANT PIPING: INSULATION SHALL BE 1" THICK FLEXIBLE ELASTOMERIC.

END OF SECTION 230700

SECTION 232300 - REFRIGERANT PIPING

PART 2 - PRODUCTS

2.1 TUBES AND FITTINGS

- COPPER TUBE: ASTM B 88, TYPE K OR TYPE L, ANNEALED OR DRAWN-TEMPER TUBING AND WROUGHT-COPPER

FITTINGS WITH BRAZED OR SOLDERED JOINTS.

- WROUGHT-COPPER FITTINGS AND UNIONS: ASME B16.22.

- SOLDER FILLER METALS: ASTM B 32. USE 95-5 TIN ANTIMONY OR ALLOY HB SOLDER TO JOIN COPPER SOCKET

FITTINGS ON COPPER PIPE.

- BRAZING FILLER METALS: AWS A5.8.

2.2 VALVES AND SPECIALTIES:

- AS REQUIRED BY THE KITCHEN EQUIPMENT MANUFACTURER.

PART 3 - EXECUTION

3.1 INSTALLATION

- INSTALL REFRIGERANT PIPING AND CHARGE WITH REFRIGERANT ACCORDING TO ASHRAE 15.

- INSTALL REFRIGERANT PIPING AS REQUIRED BY THE KITCHEN EQUIPMENT MANUFACTURER.

END OF SECTION 232300

SECTION 233100 - HVAC DUCTS AND CASINGS

PART 2 - PRODUCTS

2.1 PERFORMANCE REQUIREMENTS

- COMPLY WITH SMACNA'S "HVAC DUCT CONSTRUCTION STANDARDS - METAL AND FLEXIBLE."

- STRUCTURAL PERFORMANCE: DUCT HANGERS AND SUPPORTS SHALL WITHSTAND THE EFFECTS OF GRAVITY LOADS AND STRESSES WITHIN LIMITS AND UNDER CONDITIONS DESCRIBED IN SMACNA'S "HVAC DUCT CONSTRUCTION STANDARDS - METAL AND FLEXIBLE."

- COMPLY WITH NFPA 96 FOR DUCTS CONNECTED TO COMMERCIAL KITCHEN HOODS.

2.2 DUCTS

- GALVANIZED-STEEL SHEET: ASTM A 653/A 653M, AND A 924 WITH G90 HOT-DIP GALVANIZED COATING.

- GALVANIZED COATING DESIGNATION: G90.

B. TYPE 1 KITCHEN EXHAUST DUCTWORK

- FIELD FABRICATED RECTANGULAR KITCHEN GREASE DUCT:

- MINIMUM 16 GAUGE CARBON STEEL WHERE CONCEALED, AND OF MINIMUM 16 GAUGE STAINLESS STEEL WHERE EXPOSED. JOINTS AND SEAMS SHALL BE CONTINUOUSLY WELDED LIQUID TIGHT ON THE EXTERNAL SIDE OF THE DUCT SYSTEM.

- PROVIDE GREASE RESERVOIR AS REQUIRED BY THE REQUIREMENTS OF IMC 506.3.7.1 AND PROVIDE DUCT CLEANOUT(S) AS REQUIRED BY THE REQUIREMENTS OF IMC 506.8.3.

- COMPOSITE GREASE DUCT ENCLOSURE ASSEMBLIES: PROVIDE FLEXIBLE BLANKET-TYPE INSULATION COMPOSED OF FIBER BLANKET ENCAPSULATED IN AN ALUMINUM FOIL SCRIM, PROVIDING A NONCOMBUSTIBLE WRAP TO PROVIDE A VAPOR AND DUST BARRIER. DUCT WRAP SYSTEM SHALL HAVE FLAME SPREAD INDEX OF NOT MORE THAN 5 AND SMOKE DEVELOPED INDEX NOT EXCEEDING 5, WHEN TESTED PER ASTM E-84 METHOD. INSULATION AND JACKET SHALL BE RATED FOR OPERATING TEMPERATURES UP TO 2000°F. DUCT WRAP SYSTEM MUST COMPLY WITH ALL FIVE FIRE TESTS OF STANDARD ASTM E2336, GREASE DUCT ENCLOSURE SYSTEM, AND THE DUCT FIRESTOP SYSTEM SHALL BE ASTM E814 CLASSIFIED. FABRICATE DUCT WRAP ENCLOSURE WITH (2) LAYERS OF DUCT WRAP TO PROVIDE 2-HOUR FIRE RATING. PROVIDE COMPOSITE GREASE DUCT FIRE PROTECTION INSULATION FROM ONE OF THE FOLLOWING: THERMAL CERAMICS FIREMASTER FASTWRAP XL, UNIFRAX FyreWRAP 2.0 MAX.

- JOINT AND SEAM TAPE, AND SEALANT: COMPLY WITH UL 181A. PROVIDE POLYMERIC RUBBER TYPE SEALANT FOR USE ON BOTH INTERIOR LOCATED DUCTWORK AND DUCTWORK EXPOSED TO OUTDOOR CONDITIONS. SEALER SHALL HAVE HIGH BONDING STRENGTH FOR SURE, FIRST TIME SEALING OF JOINTS IN LOW, MEDIUM, AND HIGH PRESSURE DUCT SYSTEMS. SEALER SHALL BE HIGH IN SOLID CONTENT. PROVIDE A TWO PART TAPE SEALING SYSTEM, CONSISTING OF WOVEN FIBER TAPE IMPREGNATED WITH A GYPSUM MINERAL COMPOUND, AND A MODIFIED ACRYLIC/SILICONE ACTIVATOR THAT REACTS EXOTHERMICALLY WITH THE TAPE. TWO PART TAPE SEALING SYSTEM MUST BE RATED FOR BOTH INDOOR AND OUTDOOR APPLICATION. TAPE SHALL NOT CONTAIN ASBESTOS.

- METAL DUCT FABRICATION: COMPLY WITH SMACNA'S "HVAC DUCT CONSTRUCTION STANDARDS - METAL AND FLEXIBLE."

2.3 ACCESSORIES

- VOLUME DAMPERS AND CONTROL DAMPERS: SINGLE-BLADE AND MULTIPLE OPPOSED-BLADE DAMPERS, STANDARD LEAKAGE RATING, AND SUITABLE FOR HORIZONTAL OR VERTICAL APPLICATIONS; FACTORY FABRICATED AND COMPLETE WITH REQUIRED HARDWARE AND ACCESSORIES.

- ROUND VOLUME DAMPERS: PROVIDE MINIMUM 20 GAUGE GALVANIZED STEEL FRAME AND BLADES, MINIMUM 3/8" SQUARE STEEL AXLE, MOLDED SYNTHETIC BEARINGS, WITH LOCKING POSITION REGULATOR. REGULATOR SHALL BE POSITIONED WITH SHEET METAL BRACKET BEYOND DUCT COVERING, WHERE POSITIONING REGULATOR IS NOT ACCESSIBLE. PROVIDE COUPLING AND EXTENSION ROD WITH REGULATOR FOR CEILING OR WALL INSTALLATION, AS REQUIRED.

- RECTANGULAR VOLUME DAMPERS: PROVIDE MINIMUM 16 GAUGE GALVANIZED STEEL CHANNEL FRAME, 16 GAUGE GALVANIZED STEEL BLADES, MINIMUM 1/2" HEXAGONAL AXLE, BOLDED SYNTHETIC BEARINGS, WITH 3/8" SQUARE PLATED STEEL CONTROL SHAFT. LINKAGES SHALL BE CONCEALED IN THE FRAME. OPERATING SHAFT SHALL EXTEND BEYOND FRAME AND DUCT TO A LOCKING QUADRANT WITH ADJUSTABLE LEVER. MAXIMUM BLADE WIDTH SHALL NOT EXCEED 6".

- FLEXIBLE DUCT CONNECTORS: FLAME-RETARDED OR NONCOMBUSTIBLE FABRICS, COATINGS, AND ADHESIVES COMPLYING WITH UL 181, CLASS 1. CONNECTOR TO BE 30 OUNCE, NEOPRENE COATED, FIBERGLASS FABRIC.

- FLEXIBLE DUCTS: FACTORY ASSEMBLED, UL 181, CLASS 1, WITH 1-1/2-INCH THICK (R-5 MIN.), 1 PCF FIBERGLASS INSULATION AND REINFORCED OUTER PROTECTIVE COVER/VAPOR BARRIER. FLEXIBLE DUCT SHALL MEET NFPA 90A WITH FLAME SPREAD UNDER 25, SMOKE DEVELOPED UNDER 50, AND SHALL BE RATED FOR MINIMUM 2-INCH WG PRESSURE AND 0 TO 250°F TEMPERATURE. PROVIDE SCREW-OPERATED METAL ADJUSTABLE CLAMPING DEVICES. USE TWIST-LOCK CONICAL TAP COLLARS AT CONNECTIONS INTO SHEET METAL DUCTWORK. MAXIMUM EXTENDED LENGTH OF FLEXIBLE DUCT SHALL NOT EXCEED 5 FEET.

- TURNING VANES: PROVIDE FABRICATED TURNING VANES AND VANE RUNNERS, CONSTRUCTED IN ACCORDANCE WITH SMACNA "HVAC DUCT CONSTRUCTION STANDARDS"; PROVIDE TURNING VANES CONSTRUCTED OF CURVED BLADES, SUPPORTED WITH BARS PERPENDICULAR TO BLADES, AND SET INTO SIDE STRIPS SUITABLE FOR MOUNTING IN DUCTWORK. FOLLOW SMACNA GUIDELINES FOR SPACING SUPPORT, AND CONSTRUCTION. ALL BLADES SHALL BE DOUBLE THICKNESS AIRFOIL TYPE.

- BIRD SCREENS AND FRAMES: PROVIDE BIRD SCREENS THAT CONFORM TO ASTM E 2016, NO. 2 MESH, ALUMINUM OR STAINLESS STEEL. PROVIDE "MEDIUM-LIGHT" RATED ALUMINUM SCREENS. PROVIDE "LIGHT" RATES STAINLESS STEEL SCREENS.

- DUCT-MOUNTED ACCESS DOORS: FABRICATE ACCESS PANELS ACCORDING TO SMACNA'S "HVAC DUCT CONSTRUCTION STANDARDS - METAL AND FLEXIBLE"; FIGURES 2-10, "DUCT ACCESS DOORS AND PANELS," AND 2-11.

"ACCESS PANELS - ROUND DUCT."

PART 3 - EXECUTION

3.1 INSTALLATION

- INSTALL DUCTWORK, ACCESSORIES, AND SUPPORTS ACCORDING TO SMACNA'S "HVAC DUCT CONSTRUCTION STANDARDS - METAL AND FLEXIBLE" UNLESS OTHERWISE INDICATED.

- SEAL DUCTS TO THE FOLLOWING SEAL CLASSES ACCORDING TO SMACNA'S "HVAC DUCT CONSTRUCTION STANDARDS - METAL AND FLEXIBLE": 1-INCH WG, SEAL CLASS A.

- CONCEAL DUCTS FROM VIEW IN FINISHED AND OCCUPIED SPACES.

- AVOID PASSING THROUGH OR ABOVE ELECTRICAL EQUIPMENT SPACES AND ENCLOSURES.

- CLEAN DUCT SYSTEMS BEFORE TESTING, ADJUSTING, AND BALANCING.

3.2 TESTING, ADJUSTING, AND BALANCING

- BALANCE AIRFLOW WITHIN DISTRIBUTION SYSTEMS, INCLUDING SUBMANS, BRANCHES, AND TERMINALS TO INDICATED QUANTITIES PER SPECIFICATIONS.

END OF SECTION 233100

SECTION 233423 - HVAC EXHAUST FANS

PART 2 - PRODUCTS

2.1 PERFORMANCE REQUIREMENTS

- PRODUCTS SHALL BE LICENSED TO USE THE AMCA-CERTIFIED RATINGS SEAL.

- EXHAUST FANS SHALL COMPLY WITH UL 705. TYPE 1 FANS SHALL ALSO COMPLY WITH UL 762.

- TYPE 1 FANS TO BE DESIGNED FOR HIGH HEAT OPERATION AT 300°F.

- ELECTRICAL COMPONENTS, DEVICES, AND ACCESSORIES: LISTED AND LABELED AS DEFINED IN NFPA 70, BY A QUALIFIED TESTING AGENCY, AND MARKED FOR INTENDED LOCATION AND APPLICATION.

2.2 CENTRIFUGAL VENTILATORS

- HOUSING: REMOVABLE, SPUN-ALUMINUM, DOME TOP AND OUTLET BAFFLE; SQUARE, ONE-PIECE, ALUMINUM BASE WITH VENTURI INLET CONE.

- UPBLAST UNITS: ALUMINUM DISCHARGE BAFFLE TO DIRECT DISCHARGE AIR UPWARD, WITH RAIN AND SNOW DRAINS.

- FAN WHEELS: ALUMINUM HUB AND WHEEL WITH BACKWARD-INCLINED BLADES.

- BELT-DRIVEN DRIVE ASSEMBLY: RESILIENLY MOUNTED TO HOUSING.

- FAN SHAFT: TURNED, GROUND, AND POLISHED STEEL; KEYED TO WHEEL HUB.

- SHAFT BEARINGS: PERMANENTLY LUBRICATED, PERMANENTLY SEALED, SELF-ALIGNING BALL BEARINGS.

- PULLEYS: CAST-IRON, ADJUSTABLE-PITCH MOTOR PULLEY.

- FAN AND MOTOR ISOLATED FROM EXHAUST AIRSTREAM.

D. ACCESSORIES:

- DISCONNECT SWITCH: NON-FUSIBLE TYPE, WITH THERMAL-OVERLOAD PROTECTION, FACTORY WIRED THROUGH AN INTERNAL ALUMINUM CONDUIT.

- BIRD SCREENS: REMOVABLE, 1/2-INCH MESH, ALUMINUM OR BRASS WIRE.

- DAMPERS: COUNTERBALANCED, PARALLEL-BLADE, BACKDRAFT DAMPERS MOUNTED IN CURB BASE; FACTORY SET TO CLOSE WHEN FAN STOPS.

- MOTORIZED DAMPERS: PARALLEL-BLADE DAMPERS MOUNTED IN CURB BASE WITH ELECTRIC ACTUATOR; WIRED TO CLOSE WHEN FAN STOPS.

- GREASE BOX FOR TYPE 1 EXHAUST FANS.

- G2 GREASE GUARD FOR TYPE 1 EXHAUST FANS.

- ROOF CURBS: 20 GAUGE GALVANIZED STEEL; MITERED AND WELDED CORNERS; 1-1/2-INCH THICK, RIGID, FIBERGLASS INSULATION ADHERED TO INSIDE WALLS; AND 1-1/2-INCH WOOD NAILER. SIZE AS REQUIRED TO SUIT ROOF OPENING AND FAN BASE.

- CONFIGURATION: SELF-FLASHING WITHOUT A CANT STRIP, WITH MOUNTING FLANGE.

- OVERALL HEIGHT: 12 INCHES FOR GENERAL EXHAUST FANS; 20 INCHES FOR KITCHEN EXHAUST FANS.

- PITCH MOUNTING: MANUFACTURE CURB FOR ROOF SLOPE.

- MOUNTING PEDESTAL: GALVANIZED STEEL WITH REMOVABLE ACCESS PANEL.

- TYPE 1 ROOF CURBS TO BE VENTED TYPE.

- TYPE 1 AND TYPE 2 ROOF CURBS TO BE HINGED TYPE.

F. CAPACITIES AND CHARACTERISTICS:

- SEE SCHEDULE.

2.3 MOTORS

- COMPLY WITH NEMA DESIGNATION, TEMPERATURE RATING, SERVICE FACTOR, ENCLOSURE TYPE, AND EFFICIENCY REQUIREMENTS FOR MOTORS.

- MOTOR SIZES: MINIMUM SIZE AS INDICATED. IF NOT INDICATED, LARGE ENOUGH SO DRIVEN LOAD WILL NOT REQUIRE MOTOR TO OPERATE IN SERVICE FACTOR RANGE ABOVE 1.0.

- ENCLOSURE TYPE: TOTALLY ENCLOSED, FAN COOLED.

PART 3 - EXECUTION

3.1 INSTALLATION

- INSTALL UNITS WITH CLEARANCES FOR SERVICE AND MAINTENANCE.

- ROOF-MOUNTED UNITS: INSTALL ROOF CURB ON ROOF STRUCTURE, ACCORDING TO ARI GUIDELINE B. INSTALL AND SECURE ROOF-MOUNTED FANS ON CURBS, AND

SPECIFICATIONS - DIVISION 23 - HVAC (CONTINUED)

SECTION 233713 - DIFFUSERS, REGISTERS, AND GRILLES

- PART 1 - GENERAL
- 1.1 SECTION REQUIREMENTS
- A. SUBMITTALS:
- PRODUCT DATA: FOR EACH TYPE OF PRODUCT INDICATED, INCLUDING COLOR CHARTS FOR FACTORY FINISHES.
- PART 2 - PRODUCTS
- 2.1 DIFFUSERS, REGISTERS, AND GRILLES:
- A. REFER TO SCHEDULES FOR FINISH TYPE, COLOR, MATERIAL, AND MOUNTING.
- PART 3 - EXECUTION
- 3.1 INSTALLATION
- A. INSTALL DIFFUSERS, REGISTERS, AND GRILLES LEVEL AND PLUMB.
- B. CEILING-MOUNTED OUTLETS AND INLETS: DRAWINGS INDICATE GENERAL ARRANGEMENT OF DUCTS, FITTINGS, AND ACCESSORIES. MAKE FINAL LOCATIONS WHERE INDICATED, AS MUCH AS PRACTICAL. FOR UNITS INSTALLED IN LAY-IN CEILING PANELS, LOCATE UNITS IN THE CENTER OF PANEL UNLESS OTHERWISE INDICATED, WHERE ARCHITECTURAL FEATURES OR OTHER ITEMS CONFLICT WITH INSTALLATION, NOTIFY ARCHITECT FOR A DETERMINATION OF FINAL LOCATION.
- C. AFTER INSTALLATION, ADJUST DIFFUSERS, REGISTERS, AND GRILLES TO AIR PATTERNS INDICATED, OR AS DIRECTED, BEFORE STARTING AIR BALANCING.

END OF SECTION 233713

SECTION 237413 - PACKAGED ROOFTOP UNITS

- 1.1 SUMMARY
- A. THIS SECTION INCLUDES PACKAGED, ROOFTOP UNITS WITH THE FOLLOWING COMPONENTS AND ACCESSORIES:
- DIRECT-EXPANSION COOLING.
 - GAS FURNACE.
 - ECONOMIZER OUTDOOR-AND RETURN-AIR DAMPER SECTION.
 - INTEGRAL SPACE TEMPERATURE CONTROLS.
 - ROOF CURBS.
- 1.2 SECTION REQUIREMENTS
- A. SUBMITTALS:
- PRODUCT DATA: INCLUDE MANUFACTURER'S TECHNICAL DATA FOR EACH RTU, INCLUDING RATED CAPACITIES, DIMENSIONS, REQUIRED CLEARANCES, CHARACTERISTICS, FURNISHED SPECIALTIES, AND ACCESSORIES.
- PART 2 - PRODUCTS
- 2.1 CASING
- A. GENERAL FABRICATION REQUIREMENTS FOR CASINGS: FORMED AND REINFORCED INSULATED PANELS, FABRICATED TO ALLOW REMOVAL FOR ACCESS TO INTERNAL PARTS AND COMPONENTS, WITH JOINTS BETWEEN SECTIONS SEALED.
- B. EXTERIOR CASING MATERIAL: GALVANIZED STEEL WITH FACTORY-PAINTED FINISH, WITH PITCHED ROOF PANELS AND KNOCKOUTS WITH GROMMET SEALS FOR ELECTRICAL AND PIPING CONNECTIONS AND LIFTING LUGS.
- CASING THICKNESS: 1/6 GAUGE THICK.
- C. CASING INSULATION AND ADHESIVE: COMPLY WITH NFPA 90A.
- MATERIALS: ASTM C 1071, TYPE I.
 - THICKNESS: 1/2 INCH
 - LINER MATERIALS SHALL HAVE AIR-STREAM SURFACE INSULATED WITH A MINIMUM 1/2-IN. THICK, MINIMUM 1 1/2 LB DENSITY, FLEXIBLE FIBERGLASS INSULATION BONDED WITH A PHENOLIC BINDER, NEOPRENE COATED ON THE AIR SIDE.
 - LINER ADHESIVE: COMPLY WITH ASTM C 916, TYPE I.
- D. UNIT SHALL HAVE A THRU-THE-BASE GAS AND ELECTRICAL CONNECTIONS.
- 2.2 FANS
- OPTION A OR B:
- A. DIRECT-DRIVEN SUPPLY-AIR FANS: DOUBLE WIDTH, BACKWARD INCLINED, CENTRIFUGAL; WITH PERMANENTLY LUBRICATED, MOTOR RESILIENTLY MOUNTED IN THE FAN INLET. ALUMINUM OR PAINTED-STEEL WHEELS, AND GALVANIZED-OR PAINTED-STEEL FAN SCROLLS.
- B. BELT-DRIVEN SUPPLY-AIR FANS: DOUBLE WIDTH, FORWARD CURVED, CENTRIFUGAL; WITH PERMANENTLY LUBRICATED, SINGLE-SPEED MOTOR INSTALLED ON AN ADJUSTABLE FAN BASE RESILIENTLY MOUNTED IN THE CASING. ALUMINUM OR PAINTED-STEEL WHEELS, AND GALVANIZED-OR PAINTED-STEEL FAN SCROLLS.
- C. CONDENSER-COIL FAN: DIRECT DRIVE, PROPELLER, MOUNTED ON SHAFT OF PERMANENTLY LUBRICATED MOTOR WITH THERMAL OVERLOAD PROTECTION.
- D. POWER EXHAUST: FORWARD CURVED, SHAFT MOUNTED ON PERMANENTLY LUBRICATED MOTOR.
- 2.3 COILS
- A. SUPPLY-AIR REFRIGERANT COIL:
- ALUMINUM-PLATE FIN AND SEAMLESS INTERNALLY GROOVED COPPER TUBE IN STEEL CASING WITH EQUALIZING-TYPE VERTICAL DISTRIBUTOR.
 - POLYMER STRIP SHALL PREVENT ALL COPPER COIL FROM CONTACTING STEEL COIL FRAME OR CONDENSATE PAN.
 - CATHODIC EPOXY COATING.
 - CONDENSATE DRAIN PAN: GALVANIZED STEEL WITH CORROSION-RESISTANT COATING FORMED WITH PITCH AND DRAIN CONNECTIONS.
- B. OUTDOOR-AIR REFRIGERANT COIL:
- ALUMINUM-PLATE FIN AND SEAMLESS INTERNALLY GROOVED COPPER TUBE IN STEEL CASING WITH EQUALIZING-TYPE VERTICAL DISTRIBUTOR.
 - POLYMER STRIP SHALL PREVENT ALL COPPER COIL FROM CONTACTING STEEL COIL FRAME OR CONDENSATE PAN.
 - CATHODIC EPOXY COATING.
- C. HOT-GAS REHEAT REFRIGERANT COIL (OPTIONAL):
- ALUMINUM-PLATE FIN AND SEAMLESS INTERNALLY GROOVED COPPER TUBE IN STEEL CASING WITH EQUALIZING-TYPE VERTICAL DISTRIBUTOR.
 - POLYMER STRIP SHALL PREVENT ALL COPPER COIL FROM CONTACTING STEEL COIL FRAME OR CONDENSATE PAN.
 - CATHODIC EPOXY COATING.
- 2.4 REFRIGERANT CIRCUIT COMPONENTS
- A. NUMBER OF REFRIGERANT CIRCUITS: TWO
- B. COMPRESSOR: HERMETIC, SCROLL, MOUNTED ON VIBRATION ISOLATORS; WITH INTERNAL OVERCURRENT AND HIGH-TEMPERATURE PROTECTION, INTERNAL PRESSURE RELIEF AND CRANKCASE HEATER.
- C. REFRIGERATION SPECIALTIES:
- REFRIGERANT: R-410A
 - EXPANSION VALVE WITH REPLACEABLE THERMOSTATIC ELEMENT.
 - REFRIGERANT FILTER/DRYER.
 - MANUAL-RESET HIGH-PRESSURE SAFETY SWITCH.
 - AUTOMATIC-RESET LOW-PRESSURE SAFETY SWITCH.

- MINIMUM OFF-TIME RELAY.
 - AUTOMATIC-RESET COMPRESSOR MOTOR THERMAL OVERLOAD.
 - BRASS SERVICE VALVES INSTALLED IN COMPRESSOR SUCTION AND LIQUID LINES.
 - LOW-AMBIENT KIT HIGH-PRESSURE SENSOR.
 - HOT-GAS REHEAT SOLENOID VALVE WITH A REPLACEABLE MAGNETIC COIL.
- 2.5 AIR FILTRATION
- A. PROVIDE 2" THROW-AWAY FIBERGLASS FILTERS.
- 2.6 GAS FURNACE
- A. BURNERS: IN-SHOT TYPE CONSTRUCTED OF ALUMINUM-COATED STEEL.
- FUEL: NATURAL GAS.
 - IGNITION: DIRECT SPARK IGNITION (DSI).
- VERIFY AVAILABILITY OF HIGH-ALTITUDE FEATURE WITH MANUFACTURERS.
- HIGH-ALTITUDE KIT: FOR PROJECT ELEVATIONS MORE THAN 2,000 FEET ABOVE SEA LEVEL.
 - HEAT-EXCHANGER AND DRAIN PAN: STAINLESS STEEL.
 - INDUCED DRAFT COMBUSTION BLOWER.
 - SAFETY CONTROLS:
 - GAS CONTROL VALVE: TWO STAGE.
 - GAS TRAIN: SINGLE-BODY, REGULATED, REDUNDANT, 24-V AC GAS VALVE ASSEMBLY CONTAINING PILOT SOLENOID VALVE, PILOT FILTER, PRESSURE REGULATOR, PILOT SHUTOFF, AND MANUAL SHUTOFF.
- 2.7 DAMPERS
- A. OUTDOOR AND RETURN AIR MIXING DAMPERS: PARALLEL OR OPPOSED-BLADE GALVANIZED-STEEL DAMPERS MECHANICALLY FASTENED TO CADMIUM PLATED FOR GALVANIZED-STEEL OPERATING ROD IN REINFORCED CABINET. CONNECT OPERATING RODS WITH COMMON LINKAGE AND INTERCONNECT LINKAGES SO DAMPERS OPERATE SIMULTANEOUSLY.
- DAMPER MOTOR: MODULATING WITH ADJUSTABLE MINIMUM POSITION.
 - RELIEF AIR DAMPER: GRAVITY ACTUATED, WITH BIRD SCREEN AND HOOD.
- 2.8 ELECTRICAL POWER CONNECTION
- A. PROVIDE FOR SINGLE CONNECTION OF POWER TO UNIT WITH UNIT-MOUNTED DISCONNECT SWITCH ACCESSIBLE FROM OUTSIDE UNIT AND CONTROL-CIRCUIT TRANSFORMER WITH BUILT-IN OVERCURRENT PROTECTION.
- 2.9 CONTROLS
- A. BASIC UNIT CONTROLS:
- CONTROL-VOLTAGE TRANSFORMER.
 - WALL-MOUNTED THERMOSTAT OR SENSOR WITH THE FOLLOWING FEATURES:
 - HEAT-COOL-OFF SWITCH.
 - FAN ON-AUTO SWITCH.
 - FAN-SPEED SWITCH.
 - AUTOMATIC CHANGE-OVER.
 - ADJUSTABLE DEADBAND.
 - EXPOSED SET POINT.
 - EXPOSED INDICATION.
 - DEGREE F INDICATION.
 - UNOCCUPIED-PERIOD-OVERRIDE PUSH BUTTON.
 - DATA ENTRY AND ACCESS PORT TO INPUT TEMPERATURE AND HUMIDITY SET POINTS, OCCUPIED AND UNOCCUPIED PERIODS, AND OUTPUT ROOM TEMPERATURE AND HUMIDITY, SUPPLY-AIR TEMPERATURE, OPERATING MODE, AND STATUS.
 - WALL-MOUNTED HUMIDISTAT OR SENSOR WITH THE FOLLOWING FEATURES:
 - EXPOSED SET POINT.
 - EXPOSED INDICATION.
 - REMOTE WALL-MOUNTED ANNUNCIATOR PANEL WITH KEYED ACCESS FOR EACH UNIT:
 - LIGHTS TO INDICATE POWER ON, UNIT ALARM OR FAILURE, SMOKE DETECTION.
 - DDC CONTROLLER:
 - CONTROLLER SHALL HAVE VOLATILE-MEMORY BACKUP.
 - SAFETY CONTROL OPERATION:
 - SMOKE DETECTORS: STOP FAN AND CLOSE OUTDOOR-AIR DAMPER IF SMOKE IS DETECTED. PROVIDE ADDITIONAL CONTACTS FOR ALARM INTERFACE TO FIRE ALARM CONTROL PANEL.
 - FIRE ALARM CONTROL PANEL INTERFACE WHERE APPLICABLE.
 - LOW-DISCHARGE TEMPERATURE: STOP FAN AND CLOSE OUTDOOR-AIR DAMPER IF SUPPLY AIR TEMPERATURE IS LESS THAN 40°F.
- RETAIN FIRST SUBPARAGRAPH BELOW FOR AIR-TO-AIR HEAT-PUMP FEATURE.

- DEFROST CONTROL FOR CONDENSER COIL: PRESSURE DIFFERENTIAL SWITCH TO INITIATE DEFROST SEQUENCE.
3. UNIT SHALL BE CAPABLE OF DIRECT COMMUNICATION WITH GENERIC OPEN PROTOCOL SUCH AS BACNET MS/TP, LONTALK, OR MODBUS. THIS WILL ALLOW THE UNIT TO INTEGRATE WITH A FACILITY ENERGY MANAGEMENT SYSTEM.
4. SCHEDULED OPERATION: OCCUPIED AND UNOCCUPIED PERIODS ON SEVEN-DAY CLOCK WITH A MINIMUM OF FOUR PROGRAMMABLE PERIODS PER DAY.
5. UNOCCUPIED PERIOD:
- HEATING SETBACK: 10°F.
 - COOLING SETBACK: SYSTEM OFF.
 - OVERRIDE OPERATION: TWO HOURS.
6. SUPPLY FAN OPERATION:
- OCCUPIED PERIODS: RUN FAN CONTINUOUSLY.
 - UNOCCUPIED PERIODS: CYCLE FAN TO MAINTAIN SETBACK TEMPERATURE.
7. REFRIGERANT CIRCUIT OPERATION:
- OCCUPIED PERIODS: CYCLE OR STAGE COMPRESSORS, AND OPERATE HOT-GAS BYPASS TO MATCH COMPRESSOR OUTPUT TO COOLING LOAD TO MAINTAIN ROOM TEMPERATURE AND HUMIDITY. CYCLE CONDENSER FANS TO MAINTAIN MAXIMUM HOT-GAS PRESSURE. OPERATE LOW-AMBIENT CONTROL KIT TO MAINTAIN MINIMUM HOT-GAS PRESSURE.
 - UNOCCUPIED PERIODS: CYCLE COMPRESSORS AND CONDENSER FANS FOR HEATING TO MAINTAIN SETBACK TEMPERATURE.
 - HOT-GAS REHEAT-COIL OPERATION (OPTIONAL):
 - OCCUPIED PERIODS: HUMIDISTAT OPENS HOT-GAS VALVE TO PROVIDE HOT-GAS REHEAT, AND CYCLES COMPRESSOR.
 - UNOCCUPIED PERIODS: REHEAT NOT REQUIRED.
 - GAS FURNACE OPERATION:
 - OCCUPIED PERIODS: STAGE BURNER TO MAINTAIN ROOM TEMPERATURE.
 - UNOCCUPIED PERIODS: CYCLE BURNER TO MAINTAIN SETBACK TEMPERATURE.
 - FIXED MINIMUM OUTDOOR-AIR DAMPER OPERATION:
 - OCCUPIED PERIODS: OPEN TO 25 PERCENT.
 - UNOCCUPIED PERIODS: CLOSE THE OUTDOOR-AIR DAMPER.
 - ECONOMIZER OUTDOOR-AIR DAMPER OPERATION:
 - OCCUPIED PERIODS: OPEN TO 25 PERCENT FIXED MINIMUM INTAKE, AND MAXIMUM 100 PERCENT OF THE FAN CAPACITY TO COMPLY WITH ASHRAE CYCLE II. CONTROLLER SHALL PERMIT AIR-SIDE ECONOMIZER OPERATION WHEN OUTDOOR AIR IS LESS THAN 60 ° F. USE MIXED-AIR TEMPERATURE AND SELECT BETWEEN OUTDOOR-AIR AND RETURN-AIR ENTHALPY TO ADJUST MIXING DAMPERS DURING ECONOMIZER CYCLE OPERATION. LOCK OUT COOLING.
 - UNOCCUPIED PERIODS: CLOSE OUTDOOR-AIR DAMPER AND OPEN RETURN-AIR DAMPER.
- 2.10 ACCESSORIES
- A. DUPLEX, 115-V, GROUND-FAULT-INTERRUPTER OUTLET WITH 15-A OVERCURRENT PROTECTION. INCLUDE TRANSFORMER IF REQUIRED.
- B. LOW-AMBIENT KIT STAGED DOWN TO 0°F.
- C. FILTER DIFFERENTIAL PRESSURE SWITCH WITH SENSOR TUBING ON EITHER SIDE OF FILTER. SET FOR FINAL FILTER PRESSURE LOSS.
- D. HAIL GUARDS OF GALVANIZED STEEL, PAINTED TO MATCH CASING.
- E. DUCT MOUNTED SMOKE DETECTOR IN RETURN AIR STREAM CAPABLE OF SHUTTING DOWN THE UNIT IN THE PRESENCE OF SMOKE DETECTION.
- 2.11 ROOF CURBS
- A. MATERIALS: GALVANIZED STEEL WITH CORROSION-PROTECTION COATING, WATERTIGHT GASKETS, AND FACTORY-INSTALLED WOOD NAILER; COMPLYING WITH NRCA STANDARDS.
- CURB INSULATION AND ADHESIVE: COMPLY WITH NFPA 90A OR NFPA 90B.
 - MATERIALS: ASTM C 1071, TYPE I OR II.
 - THICKNESS: 1-1/2 INCHES.
 - APPLICATION: FACTORY APPLIED WITH ADHESIVE AND MECHANICAL FASTENERS TO THE INTERNAL SURFACE OF CURB.
 - LINER ADHESIVE: COMPLY WITH ASTM C 916, TYPE I.
 - MECHANICAL FASTENERS: GALVANIZED STEEL, SUITABLE FOR ADHESIVE ATTACHMENT, MECHANICAL ATTACHMENT, OR WELDING ATTACHMENT TO DUCT WITHOUT DAMAGING LINER WHEN APPLIED AS RECOMMENDED BY MANUFACTURER AND WITHOUT CAUSING LEAKAGE IN CABINET.
 - LINER MATERIALS SHALL HAVE AIR-STREAM SURFACE INSULATED WITH A MINIMUM 1/2-IN. THICK, MINIMUM 1 1/2 LB DENSITY, FLEXIBLE FIBERGLASS INSULATION BONDED WITH A PHENOLIC BINDER, NEOPRENE COATED ON THE AIR SIDE.
 - LINER ADHESIVE: COMPLY WITH ASTM C 916, TYPE I.
 - CURB HEIGHT: 14 INCHES TYPICAL. PROVIDE 24 INCH CURB IN AREAS WITH EXPECTED HEAVY SNOWFALL.
- PART 3 - EXECUTION
- 3.1 EXAMINATION
- A. EXAMINE SUBSTRATES, AREAS, AND CONDITIONS, WITH INSTALLER PRESENT, FOR COMPLIANCE WITH REQUIREMENTS FOR INSTALLATION TOLERANCES AND OTHER CONDITIONS AFFECTING PERFORMANCE OF RTUS.
- B. EXAMINE ROUGHING-IN FOR RTUS TO VERIFY ACTUAL LOCATIONS OF PIPING AND DUCT CONNECTIONS BEFORE EQUIPMENT INSTALLATION.
- C. EXAMINE ROOFS FOR SUITABLE CONDITIONS WHERE RTUS WILL BE INSTALLED.
- D. PROCEED WITH INSTALLATION ONLY AFTER UNSATISFACTORY CONDITIONS HAVE BEEN CORRECTED.
- 3.2 INSTALLATION
- A. ROOF CURB: INSTALL ON ROOF STRUCTURE, LEVEL AND SECURE. INSTALL RTUS ON CURBS AND COORDINATE ROOF

- PENETRATIONS AND FLASHING WITH ROOF CONSTRUCTION. RTUS TO UPPER CURB RAIL, AND SECURE CURB BASE TO ROOF FRAMING OR CONCRETE BASE WITH ANCHOR BOLTS.
- 3.3 CONNECTIONS
- A. THE FOLLOWING ARE SPECIFIC CONNECTION REQUIREMENTS:
- INSTALL DUCTS TO TERMINATION AT TOP OF ROOF CURB.
 - REMOVE ROOF DECKING ONLY AS REQUIRED FOR PASSAGE OF DUCTS. DO NOT CUT OUT DECKING UNDER ENTIRE ROOF CURB.
 - COORDINATION
 - CONTRACTOR TO COORDINATE WITH KITCHEN EQUIPMENT SUPPLIER TO ENSURE THAT THE RTUS ARE COORDINATED WITH THE KITCHEN EQUIPMENT, PARTICULARLY THE EXHAUST HOODS AND THE MAKE-UP AIR UNIT, TO PROPERLY PRESSURIZE THE BUILDING/SPACE.
 - CONTRACTOR TO ENSURE THAT ALL THERMOSTATS AND SENSORS ARE COMPATIBLE WITH THE RTU CONTROLS.
 - FIELD QUALITY CONTROL
 - MANUFACTURER'S FIELD SERVICE: ENGAGE A FACTORY-AUTHORIZED SERVICE REPRESENTATIVE TO INSPECT, TEST, AND ADJUST COMPONENTS, ASSEMBLIES, AND EQUIPMENT INSTALLATIONS, INCLUDING CONNECTIONS. REPORT RESULTS IN WRITING.
 - PERFORM TESTS AND INSPECTIONS AND PREPARE TEST REPORTS.
 - MANUFACTURER'S FIELD SERVICE: ENGAGE A FACTORY-AUTHORIZED SERVICE REPRESENTATIVE TO INSPECT COMPONENTS, ASSEMBLIES, AND EQUIPMENT INSTALLATIONS, INCLUDING CONNECTIONS, AND TO ASSIST IN TESTING. REPORT RESULTS IN WRITING.
 - TESTS AND INSPECTIONS:
 - AFTER INSTALLING RTUS AND AFTER ELECTRICAL CIRCUITRY HAS BEEN ENERGIZED, TEST UNITS FOR COMPLIANCE WITH REQUIREMENTS.
 - OPERATIONAL TEST: AFTER ELECTRICAL CIRCUITRY HAS BEEN ENERGIZED, START UNITS TO CONFIRM PROPER MOTOR ROTATION AND UNIT OPERATION.
 - TEST AND ADJUST CONTROLS AND SAFETIES. REPLACE DAMAGED AND MALFUNCTIONING CONTROLS AND EQUIPMENT.
 - REMOVE AND REPLACE MALFUNCTIONING UNITS AND RETEST AS SPECIFIED ABOVE.
 - STARTUP SERVICE
 - ENGAGE A FACTORY-AUTHORIZED SERVICE REPRESENTATIVE TO PERFORM STARTUP SERVICE.
 - COMPLETE INSTALLATION AND STARTUP CHECKS ACCORDING TO MANUFACTURER'S WRITTEN INSTRUCTIONS AND DO THE FOLLOWING:
 - INSPECT FOR VISIBLE DAMAGE TO UNIT CASING, FURNACE COMBUSTION CHAMBER, COMPRESSOR, COILS, AND FANS.
 - VERIFY THAT LABELS ARE CLEARLY VISIBLE, CLEARANCES HAVE BEEN PROVIDED FOR SERVICING, CONTROLS ARE CONNECTED AND OPERABLE, AND FILTERS ARE INSTALLED.
 - CLEAN CONDENSER COIL AND FURNACE AND INSPECT FOR CONSTRUCTION DEBRIS.
 - REMOVE PACKING FROM VIBRATION ISOLATORS.
 - VERIFY LUBRICATION ON FAN AND MOTOR BEARINGS.
 - INSPECT FAN-WHEEL ROTATION FOR MOVEMENT IN CORRECT DIRECTION WITHOUT VIBRATION AND BINDING.
 - ADJUST FAN BELTS TO PROPER ALIGNMENT AND TENSION.
 - START UNIT ACCORDING TO MANUFACTURER'S WRITTEN INSTRUCTIONS.
 - INSPECT AND RECORD PERFORMANCE OF INTERLOCKS AND PROTECTIVE DEVICES; VERIFY SEQUENCES.
 - OPERATE UNIT FOR AN INITIAL PERIOD AS RECOMMENDED OR REQUIRED BY MANUFACTURER.
 - PERFORM THE FOLLOWING OPERATIONS FOR BOTH MINIMUM AND MAXIMUM FIRING. ADJUST BURNER FOR PEAK EFFICIENCY.
 - MEASURE GAS PRESSURE ON MANIFOLD.
 - INSPECT OPERATION OF POWER VENTS.
 - MEASURE SUPPLY-AIR TEMPERATURE AND VOLUME WHEN BURNER IS AT MAXIMUM FIRING RATE AND WHEN BURNER IS OFF. CALCULATE USEFUL HEAT TO SUPPLY AIR.
 - ADJUST AND INSPECT HIGH-TEMPERATURE LIMITS.
 - INSPECT OUTDOOR-AIR DAMPERS FOR PROPER STROKE AND INTERLOCK WITH RETURN-AIR DAMPERS.
 - INSPECT CONTROLS FOR CORRECT SEQUENCING OF HEATING, MIXING DAMPERS, REFRIGERATION, AND NORMAL AND EMERGENCY SHUTDOWN.
 - SIMULATE MAXIMUM COOLING DEMAND AND INSPECT THE FOLLOWING:
 - COMPRESSOR REFRIGERANT SUCTION AND HOT-GAS PRESSURES.
 - SHORT CIRCUITING OF AIR THROUGH CONDENSER COIL OR FROM CONDENSER FANS TO OUTDOOR-AIR INTAKE.
 - VERIFY OPERATION OF REMOTE PANEL INCLUDING PILOT-LIGHT OPERATION AND FAILURE MODES. INSPECT THE FOLLOWING:
 - HIGH-TEMPERATURE LIMIT ON GAS-FIRED HEAT EXCHANGER.
 - LOW-TEMPERATURE SAFETY OPERATION.
 - FILTER HIGH-PRESSURE DIFFERENTIAL ALARM.
 - ECONOMIZER TO MINIMUM OUTDOOR-AIR CHANGE-OVER.
 - RELIEF-AIR FAN OPERATION.
 - SMOKE ALARMS.
 - AFTER STARTUP AND PERFORMANCE TESTING AND PRIOR TO SUBSTANTIAL COMPLETION, REPLACE EXISTING FILTERS WITH NEW FILTERS.

3.7 CLEANING AND ADJUSTING

A. OCCUPANCY ADJUSTMENTS: WHEN REQUESTED WITHIN 12 MONTHS OF DATE OF SUBSTANTIAL COMPLETION, PROVIDE ON-SITE ASSISTANCE IN ADJUSTING SYSTEM TO SUIT ACTUAL OCCUPIED CONDITIONS. PROVIDE UP TO TWO VISITS TO SITE DURING OTHER-THAN-NORMAL OCCUPANCY HOURS FOR THIS PURPOSE.

B. AFTER COMPLETING SYSTEM INSTALLATION AND TESTING, ADJUSTING, AND BALANCING RTU AND AIR-DISTRIBUTION SYSTEMS, CLEAN FILTER HOUSINGS AND INSTALL NEW FILTERS.



10-24-22



NEW RESTAURANT FOR:
ARBY'S - INSPIRE DUAL REG 40 - STD
 2010 SOUTH GREEN AVENUE
 PURCELL, OKLAHOMA 73080
 FOR
 RB AMERICAN GROUP
 6200 OAK TREE BLVD, INDEPENDENCE, OH 44131

PROJECT NUMBER:

ISSUE	DATE
PRELIMINARY	10-24-2022
REVISION	

SPECIFICATIONS MECHANICAL

SHEET:

M7.2